

*Fort Bend County, Texas
Invitation for Bid*



*Hot Water Distribution Repairs at the Fort Bend County West Tower Jail
BID 18-078*

SUBMIT BIDS TO:

Fort Bend County
Purchasing Department
Travis Annex
301 Jackson, Suite 201
Richmond, TX 77469

Note: All correspondence must include the term
“Purchasing Department” in address to assist in
proper delivery

SUBMIT NO LATER THAN:

Tuesday, June 19, 2018
2:00 PM (Central)

MARK ENVELOPE:

**BID 18-078
Hot Water Distribution Repairs**

***ALL BIDS MUST BE RECEIVED IN AND TIME/DATE STAMPED BY THE PURCHASING OFFICE
OF FORT BEND COUNTY ON OR BEFORE THE SPECIFIED TIME/DATE STATED ABOVE.***

BIDS RECEIVED AS REQUIRED WILL THEN BE OPENED AND PUBLICLY READ.

BIDS RECEIVED AFTER THE SPECIFIED TIME, WILL BE RETURNED UNOPENED.

Results will not be given by phone.
Results will be provided to bidder in writing
after Commissioners Court award.

Requests for information must be in
writing and directed to:
Jaime Kovar
Assistant County Purchasing Agent
Jaime.kovar@fortbendcountytexas.gov

Vendor Responsibilities:

- Download and complete any addendums. (Addendums will be posted on the Fort Bend County website no
Later than 48 hours prior to bid opening)
- Submit response in accordance with requirements stated on the cover of this document.
- DO NOT submit responses via email or fax.



COUNTY PURCHASING AGENT

Fort Bend County, Texas

Vendor Information

Debbie Kaminski, CPPB
County Purchasing Agent

Office (281) 341-8640

| | | |
|--|---|--|
| Legal Company Name <small>(top line of W9)</small> | | |
| Business Name <small>(if different from legal name)</small> | | |
| Federal ID # or S.S. # | | |
| Type of Business | <input type="checkbox"/> Corporation/LLC <input type="checkbox"/> Partnership <input type="checkbox"/> Sole Proprietor/Individual <input type="checkbox"/> Tax Exempt Organization | |
| Publicly Traded Business | <input type="checkbox"/> No <input type="checkbox"/> Yes Ticker Symbol _____ | |
| Remittance Address | | |
| City/State/Zip | | |
| Physical Address | | |
| City/State/Zip | | |
| Phone/Fax Number | Phone: _____ Fax: _____ | |
| Contact Person | | |
| E-mail | | |
| Check all that apply to the company listed above and provide certification number. | DBE-Disadvantaged Business Enterprise <input type="checkbox"/> Certification # _____ SBE-Small Business Enterprise <input type="checkbox"/> Certification # _____ HUB –Texas Historically Underutilized Business <input type="checkbox"/> Certification # _____ WBE-Women’s Business Enterprise <input type="checkbox"/> Certification # _____ | |
| Company’s gross annual receipts | <input type="checkbox"/> <\$500,000 | <input type="checkbox"/> \$500,000-\$4,999,999 |
| | <input type="checkbox"/> \$5,000,000-\$16,999,999 | <input type="checkbox"/> \$17,000,000-\$22,399,999 |
| | <input type="checkbox"/> >\$22,400,000 | |
| NAICs codes (Please enter all that apply) | | |
| Signature of Authorized Representative | | |
| Printed Name | | |
| Title | | |
| Date | | |

THIS FORM MUST BE SUBMITTED WITH THE SOLICITATION RESPONSE.

1.0 GENERAL REQUIREMENTS:

- 1.1 Read this entire document carefully. Follow all instructions. You are responsible for fulfilling all requirements and specifications. Be sure you understand them.
- 1.2 General Requirements apply to all advertised bids; however, these may be superseded, whole or in part, by the scope, special requirements, specifications, special specifications or other data contained herein.
- 1.3 Governing Law: Bidder is advised that these requirements shall be fully governed by the laws of the State of Texas and that Fort Bend County may request and rely on advice, decisions and opinions of the Attorney General of Texas and the County Attorney concerning any portion of these requirements.
- 1.4 Bid Form Completion: Fill out, sign, and return to the Fort Bend County Purchasing Department one (1) complete bid form. An authorized representative of the bidder must sign the Contract Sheet. The Contract will be binding only when signed by the County Judge, Fort Bend County and a purchase order authorizing the item(s) desired has been issued. The use of corrective fluid is not acceptable and may result in the disqualification of bid. If an error is made, the bidder must draw a line through error and initial each change.
- 1.5 Bid Returns: Bidders must return all completed bids to the Fort Bend County Purchasing Department at 301 Jackson, Suite 201 Richmond Texas no later than 2:00 P.M. on the date specified. Late bids will not be accepted. Bids must be submitted in a sealed envelope, addressed as follows: Fort Bend County Purchasing Agent, Travis Annex, 301 Jackson, Suite 201 Richmond, Texas 77469.
- 1.6 Addenda: No interpretation of the meaning of the drawings, specifications or other bid documents will be made to any bidder orally. All requests for such interpretations must be made in writing addressed to Jaime Kovar, Assistant Purchasing Agent, 301, Jackson, Suite 201, Richmond, Texas, 77469, E-mail: Jaime.Kovar@fortbendcountytexas.gov. Any and all interpretations and any supplemental instructions will be in the form of written addenda to the contract documents which will be posted on Fort Bend County's website. Addenda will **ONLY** be issued by the Fort Bend County Purchasing Agent. It is the sole responsibility of each bidder to insure receipt of any and all addenda. All addenda issued will become part of the contract documents. Bidders must sign and include it in the returned bid package. Deadline for submission of questions and/or clarification is no later than **Monday, June 11, 2018 at 3:00PM (central)** Requests received after the deadline will not be responded to due to the time constraints of this bid process.
- 1.7 References: All bidders must submit, **WITH BID**, at least three (3) references from clients for whom a project similar to that specified herein has been

successfully accomplished. References must include clients name, contact person and telephone number.

- 1.8 Bid Bond: All bidders must submit, **WITH BID**, a cashier's check or certified check for at least five percent (5%) of the total bid price, payable to the order of Fort Bend County, or a Bid Bond in the same amount issued by a surety, acceptable to Fort Bend County, authorized to do business in the State of Texas, as a guarantee that the Bidder will do the work described herein at the rates stated herein. Unsuccessful bidder's Cashier's Check or Certified Check will be returned only after a written request to do so have been received in the Office of the Fort Bend County Purchasing Agent.
- 1.9 Material Safety Data Sheets: Under the "Hazardous Communication Act", commonly known as the "Texas Right to Know Act", a bidder must provide to Fort Bend County and using departments, with each delivery, material safety data sheets, which are, applicable to hazardous substances defined in the Act. Bidders are obligated to maintain a current, updated file in the Fort Bend County Purchasing Department. Failure of the bidder to maintain such a file will be cause to reject any bid applying thereto.
- 1.10 Pricing: Prices for all goods and/or services shall be firm for the duration of this Contract and shall be stated on the bid sheet. Prices shall be all inclusive. No price changes, additions, or subsequent qualifications will be honored during the course of the Contract. All prices must be written in ink or typewritten. If there are any additional charges of any kind, other than those mentioned above, specified or unspecified, bidder MUST indicate the items required and attendant costs or forfeit the right to payment for such items.
- 1.11 Term Contracts: If the Contract is intended to cover a specific time period, said time will be given in the specifications under scope.
- 1.12 Recycled Materials: Fort Bend County encourages the use of products made of recycled materials and shall give preference in purchasing to products made of recycled materials if the products meet applicable specifications as to quantity and quality. Fort Bend County will be the sole judge in determining product preference application.
- 1.13 Evaluation: Evaluation shall be used as a determinant as to which bid items or services are the most efficient and/or most economical for Fort Bend County. It shall be based on all factors which have a bearing on price and performance of the items in the user environment. All bids are subject to tabulation by the Fort Bend County Purchasing Department and recommendation to Fort Bend County Commissioners Court. Compliance with all bid requirements, delivery and needs of the using department are considerations in evaluating bids. Pricing is NOT the only criteria for making a recommendation. The Fort Bend County Purchasing Department reserves the right to contact any bidder, at any time, to clarify, verify

or request information with regard to any bid.

- 1.14 **Disqualification of Bidder:** Upon signing this bid document, a bidder offering to sell supplies, materials, services, or equipment to Fort Bend County certifies that the bidder has not violated the antitrust laws of this state codified in section 15.01, et seq., Business & Commerce Code, or the federal antitrust laws, and has not communicated directly or indirectly the bid made to any competitor or any other person engaged in such line of business. Any or all bids may be rejected if Fort Bend County believes that collusion exists among the bidders. Bids in which the prices are obviously unbalanced may be rejected. If multiple bids are submitted by a bidder and after the bids are opened, one of the bids is withdrawn, the result will be that all of the bids submitted by that bidder will be withdrawn; however, nothing herein prohibits a vendor from submitting multiple bids for different products or services.
- 1.15 **Awards:** Fort Bend County reserves the right to award this Contract on the basis of lowest and best bid in accordance with the laws of the State of Texas, to waive any formality or irregularity, to make awards to more than one bidder, to reject any or all bids. In the event the lowest dollar bidder meeting specifications is not awarded a contract, the bidder may appear before the Commissioners Court and present evidence concerning its responsibility.
- 1.16 **Contract Obligation:** Fort Bend County Commissioners Court must award the Contract and the County Judge or other person authorized by the Fort Bend County Commissioners Court must sign the Contract before it becomes binding on Fort Bend County or the bidders. Department heads are not authorized to sign agreements for Fort Bend County. Binding agreements shall remain in effect until all products and/or services covered by this purchase have been satisfactorily delivered and accepted.

2.0 SCOPE:

It is the intent of Fort Bend County to contract with one (1) vendor to furnish all labor, materials, supplies, equipment and PPE (personal protective equipment), services, labor and supervision necessary to install hot water distribution repairs at the Fort Bend County West Tower Jail, 1410 Williams Way Boulevard, Richmond, TX 7746, hereinafter referred to as the "Project," as specified herein.

3.0 PRE-BID CONFERENCE:

A pre-bid conference will be conducted on **Tuesday, June 5, 2018 at 9:00AM** (central) at the Fort Bend County Sheriff's Office, 1410 Williams Way Boulevard, Richmond, TX 77469 with a site visit immediately following the pre-bid conference. Attendance is non-mandatory; however, all bidders are encouraged to attend. This is the only date and time vendors will be permitted with a County representative.

4.0 LIQUIDATED DAMAGES:

If the Project is not substantially complete within the contract time as adjusted by extension of time approved by Commissioner Court, Fort Bend County will deduct (from the final payment, as liquidated damages), the sum of five hundred (\$500.00) per calendar day that the Project remains not substantially complete, such sum is agreed upon as a reasonable and proper measure of damages which Fort Bend County will sustain per day by failure of Contractor to substantially complete work within the contract time. It is understood that said sum shall be considered as liquidated damages and shall in no sense be considered as a penalty against the Contractor.

5.0 COMPLETION TIME AND PAYMENT:

5.1 Fort Bend County shall pay the Contractor in current funds for the Contractor's performance of the Contract the contract sum, as stated herein, after receipt of notice to proceed and a purchase order issued by the Fort Bend County Purchasing Agent.

5.2 Based upon Applications for payment submitted to the Facilities Department, Fort Bend County shall make progress payments on account of the contract sum to the Contractor as provided below and elsewhere in the contract documents.

5.2.1 The period covered by each application for payment shall be one calendar month ending on the last day of the month.

5.2.2 Provided an application for payment is received by the Facilities Department not later than the 15th day of a month, Fort Bend County shall make payment to the Contractor not later than the 15th day of the next month. If an application for payment is received by the Facilities Department after the application deadline fixed above, payment shall be made by Fort Bend County not later than 30 days after the Facilities Department receives the application for payment.

5.2.3 Application for payment shall indicate the percentage of completion of each portion of the Project as of the end of the period covered by the application for payment.

5.2.4 Subject to the provisions of the contract documents, the amount of each progress payment shall be computed as follows:

5.2.4.1 Take that portion of the contract sum properly allocable to completed Project less retainage of ten percent (10%).

5.2.4.2 Add that portion of the contract sum properly allocable to materials and equipment delivered and suitably stored at the site for subsequent incorporation in the completed construction (or, if approved by Fort Bend County, suitably stored off the site at a

location agreed upon in writing), less retainage of ten percent (10%).

5.2.4.3 Subtract the aggregate of previous payments made by Fort Bend County.

5.2.4.4 The progress payment amount as determined in above shall be further modified under the following circumstances:

Add, upon substantial completion of the Project, a sum sufficient to increase the total payments to one hundred percent (100%) of the contract sum, less such amounts as Fort Bend County shall determine for incomplete work and unsettled claims.

5.2.4.5 Final payment, constituting the entire unpaid balance of the contract sum, shall be made by Fort Bend County to the Contractor when the Contract has been fully performed by the Contractor.

5.3 Before the first application for payment, the Contractor shall submit to the Facilities Department a schedule of values allocated to various portions of the work, prepared in such form and supported by such data to substantiate its accuracy as the Facilities Department may require. This schedule, unless objected to by the Facilities Department shall be used as a basis for reviewing the Contractor's application for payment.

5.4 Contractor must provide with each application for payment a contractor's affidavit certifying bills against the Contractor for labor, material and expendable equipment employed in the performance of Contractor have been paid in full prior to acceptance of final payment from Fort Bend County.

5.5 The Contractor will permit Fort Bend County, or any duly authorized agent of Fort Bend County, to inspect and examine the books and records of the Contractor for the purpose of verifying the amount of work performed under the Contract. Fort Bend County's right to inspect survives the termination of the Contract for a period of five years.

6.0 LIMIT OF APPROPRIATION:

Prior to the execution of this Contract, Contractor has been advised by County, and Contractor clearly understands and agrees, such understanding and agreement being of the absolute essence to this Contract, that County shall have available only those funds specifically allocated in this Contract to fully discharge any and all liabilities which may be incurred by County in bringing this Project to an absolute conclusion, resulting in a complete, fully furnished, fully equipped and fully usable facility, and that the total of any and all basic construction costs, costs of providing the required furnishing and equipment, all fees and compensation of any sort to the Contractor,

and any and all costs for any and all things or purposes enuring under or out of this Contract, irrespective of the nature thereof, shall not exceed said specifically allocated sum, notwithstanding any word, statement or thing contained in or inferred from the preceding provision of this Contract which might in any light by any person be interpreted to the contrary.

7.0 RIGHT TO ASSURANCE:

Whenever Fort Bend County in good faith has reason to question the Contractor's intent to perform, Fort Bend County may demand that the Contractor give written assurance of its intent to perform. In the event that a demand is made and no assurance is given within five (5) days, Fort Bend County may treat this failure as an anticipatory repudiation of the Contract.

8.0 PERFORMANCE AND PAYMENT BONDS:

Performance and Payment Bonds: In the event the total accepted bid price exceeds \$25,000 the Contractor must provide to the Office of the County Purchasing Agent, a performance bond and a payment bond, each in the amount of 100% of the total contract sum within ten (10) calendar days after receipt of notification of bid award. Such bonds shall be executed by a corporate surety duly authorized and admitted to do business in the State of Texas and licensed in the State of Texas to issue surety bonds with a Best Rating of "A" or better. Fort Bend County reserves the right to accept or reject any surety company proposed by the Contractor. In the event Fort Bend County rejects, the proposed surety company, the Contractor will be afforded five (5) additional days to submit the required bonds issued by a surety company acceptable to Fort Bend County.

9.0 POWER OF ATTORNEY:

An attorney-in-fact who signs a bid bond, performance bond or payment bond must file with each bond a certified and effectively dated copy of his or her power of attorney.

10.0 INSURANCE:

10.1 All respondents must submit, with response, a current certificate of insurance indicating coverage in the amounts stated below. In lieu of submitting a certificate of insurance, respondents may submit, with response, a notarized statement from an Insurance company, authorized to conduct business in the State of Texas, and acceptable to Fort Bend County, guaranteeing the issuance of an insurance policy, with the coverage stated below, to the firm named therein, if successful, upon award of this Contract. Failure to provide current insurance certificate or notarized statement will result in disqualification of submittal.

10.2 At contract execution, contractor shall furnish County with properly executed certificates of insurance which shall evidence all insurance required and provide that such insurance shall not be canceled, except on 30 days prior written notice to County. Contractor shall provide certified copies of insurance endorsements and/or policies if requested by County. Contractor shall maintain such insurance

coverage from the time Services commence until Services are completed and provide replacement certificates, policies and/or endorsements for any such insurance expiring prior to completion of Services. Contractor shall obtain such insurance written on an Occurrence form (or a Claims Made form for Professional Liability insurance) from such companies having Best's rating of A/VII or better, licensed or approved to transact business in the State of Texas, and shall obtain such insurance of the following types and minimum limits:

- 10.2.1 Workers' Compensation insurance. Substitutes to genuine Workers' Compensation Insurance will not be allowed.
- 10.2.2 Employers' Liability insurance with limits of not less than \$1,000,000 per injury by accident, \$1,000,000 per injury by disease, and \$1,000,000 per bodily injury by disease.
- 10.2.3 Commercial general liability insurance with a limit of not less than \$1,000,000 each occurrence and \$2,000,000 in the annual aggregate. Policy shall cover liability for bodily injury, personal injury, and property damage and products/completed operations arising out of the business operations of the policyholder.
- 10.2.4 Business Automobile Liability coverage with a combined Bodily Injury/Property Damage limit of not less than \$1,000,000 each accident. The policy shall cover liability arising from the operation of licensed vehicles by policyholder.
- 10.3 County and the members of Commissioners Court shall be named as additional insured to all required coverage except for Workers' Compensation and Professional Liability (if required). All Liability policies including Workers' Compensation written on behalf of contractor, excluding Professional Liability, shall contain a waiver of subrogation in favor of County and members of Commissioners Court.
- 10.4 If required coverage is written on a claims-made basis, contractor warrants that any retroactive date applicable to coverage under the policy precedes the effective date of the contract; and that continuous coverage will be maintained or an extended discovery period will be exercised for a period of two (2) years beginning from the time that work under the agreement is completed.
- 10.5 Contractor shall not commence any portion of the work under this Contract until it has obtained the insurance required herein and certificates of such insurance have been filed with and approved by Fort Bend County.
- 10.6 No cancellation of or changes to the certificates, or the policies, may be made without sixty (60) days prior, written notification to Fort Bend County.

- 10.7 Approval of the insurance by Fort Bend County shall not relieve or decrease the liability of the Contractor.

11.0 INDEMNIFICATION:

Respondent shall save harmless County from and against all claims, liability, and expenses, including reasonable attorney's fees, arising from activities of respondent, its agents, servants or employees, performed under this agreement that result from the negligent act, error, or omission of respondent or any of respondent's agents, servants or employees.

- 11.1 Respondent shall timely report all such matters to Fort Bend County and shall, upon the receipt of any such claim, demand, suit, action, proceeding, lien or judgment, not later than the fifteenth day of each month; provide Fort Bend County with a written report on each such matter, setting forth the status of each matter, the schedule or planned proceedings with respect to each matter and the cooperation or assistance, if any, of Fort Bend County required by Respondent in the defense of each matter.
- 11.2 Respondent's duty to defend, indemnify and hold Fort Bend County harmless shall be absolute. It shall not abate or end by reason of the expiration or termination of any contract unless otherwise agreed by Fort Bend County in writing. The provisions of this section shall survive the termination of the contract and shall remain in full force and effect with respect to all such matters no matter when they arise.
- 11.3 In the event of any dispute between the parties as to whether a claim, demand, suit, action, proceeding, lien or judgment appears to have been caused by or appears to have arisen out of or in connection with acts or omissions of Respondent, Respondent shall never-the-less fully defend such claim, demand, suit, action, proceeding, lien or judgment until and unless there is a determination by a court of competent jurisdiction that the acts and omissions of Respondent are not at issue in the matter.
- 11.4 Respondent's indemnification shall cover, and Respondent agrees to indemnify Fort Bend County, in the event Fort Bend County is found to have been negligent for having selected Respondent to perform the work described in this request.
- 11.5 The provision by Respondent of insurance shall not limit the liability of Respondent under an agreement.
- 11.6 Respondent shall cause all trade contractors and any other contractor who may have a contract to perform construction or installation work in the area where work will be performed under this request, to agree to indemnify Fort Bend County and to hold it harmless from all claims for bodily injury and property damage that may arise from said Respondent's operations. Such provisions shall be in form satisfactory to Fort Bend County.

11.7 Loss Deduction Clause - Fort Bend County shall be exempt from, and in no way liable for, any sums of money which may represent a deductible in any insurance policy. The payment of deductibles shall be the sole responsibility of Respondent and/or trade contractor providing such insurance.

12.0 PREVAILING WAGES:

This project is subject to the prevailing wage rate requirements of Chapter 2258 of the Government Code. The Contractor shall pay Fort Bend County sixty dollars (\$60.00) for each worker employed by the Contractor for the provision of services described herein for each calendar day or part of the day that the worker is paid less than the below stated rates. Contractors may also visit www.wdol.gov/dba.aspx.

General Decision Number: TX180297 01/12/2018 TX297

Superseded General Decision Number: TX20170297

State: Texas

Construction Type: Building

County: Fort Bend County in Texas.

BUILDING CONSTRUCTION PROJECTS (does not include single family homes or apartments up to and including 4 stories).

Note: Under Executive Order (EO) 13658, an hourly minimum wage of \$10.35 for calendar year 2018 applies to all contracts subject to the Davis-Bacon Act for which the contract is awarded (and any solicitation was issued) on or after January 1, 2015. If this contract is covered by the EO, the contractor must pay all workers in any classification listed on this wage determination at least \$10.35 (or the applicable wage rate listed on this wage determination, if it is higher) for all hours spent performing on the contract in calendar year 2018. The EO minimum wage rate will be adjusted annually. Please note that this EO applies to the above-mentioned types of contracts entered into by the federal government that are subject to the Davis-Bacon Act itself, but it does not apply to contracts subject only to the Davis-Bacon Related Acts, including those set forth at 29 CFR 5.1(a)(2)-(60). Additional information on contractor requirements and worker protections under the EO is available at www.dol.gov/whd/govcontracts.

| Modification Number | Publication Date |
|---------------------|------------------|
| 0 | 01/05/2018 |
| 1 | 01/12/2018 |

ASBE0022-009 06/01/2017

| | Rates | Fringes |
|--|----------|---------|
| ASBESTOS WORKER/HEAT & FROST INSULATOR (Duct, Pipe and Mechanical System Insulation).. | \$ 23.26 | 12.92 |

BOIL0074-003 01/01/2017

BOILERMAKER \$ 28.00 22.35

CARP0551-008 04/01/2016

CARPENTER (Excludes Acoustical Ceiling Installation, Drywall Hanging, Form Work and Metal Stud Installation) \$ 23.05 8.78

ELEC0716-005 08/28/2017

ELECTRICIAN (Excludes Low Voltage Wiring and Installation Of Alarms) \$ 32.25 9.14

ELEV0031-003 01/01/2018

ELEVATOR MECHANIC \$ 41.28 32.645+a+b

FOOTNOTES

A. 6% under 5 years based on regular hourly rate for all hours worked. 8% over 5 years based on regular hourly rate for all hours worked.

B. Holidays: New Year's Day; Memorial Day; Independence Day; Labor Day; Thanksgiving Day; Friday after Thanksgiving Day; Christmas Day; and Veterans Day.

ENGI0450-002 04/01/2014

POWER EQUIPMENT OPERATOR

CRANES \$ 34.85 9.85

IRON0084-002 06/01/2017

IRONWORKER (ORNAMENTAL AND STRUCTURAL) \$ 23.27 7.12

PLAS0079-004 01/01/2015

PLASTERER \$ 19.92 1.00

PLUM0068-002 10/01/2017

PLUMBER \$ 34.90 10.54

PLUM0211-010 10/01/2017

PIPEFITTER (Including HVAC Pipe Installation) \$ 34.10 11.71

SHEE0054-003 07/01/2017

| | | |
|---|----------|-------|
| SHEET METAL WORKER (Excludes HVAC Duct and Unit Installation) | \$ 27.72 | 13.70 |
|---|----------|-------|

SUTX2014-023 07/21/2014

| | | |
|--|----------|------|
| ACOUSTICAL CEILING MECHANIC | \$ 16.41 | 3.98 |
| BRICKLAYER | \$ 19.86 | 0.00 |
| CAULKER | \$ 15.36 | 0.00 |
| CEMENT MASON/CONCRETE FINISHER | \$ 13.82 | 0.00 |
| DRYWALL FINISHER/TAPER | \$ 16.30 | 3.71 |
| DRYWALL HANGER AND METAL STUD INSTALLER | \$ 17.45 | 3.96 |
| ELECTRICIAN (Alarm Installation Only) | \$ 17.97 | 3.37 |
| ELECTRICIAN (Low Voltage Wiring Only) | \$ 18.00 | 1.68 |
| FLOOR LAYER: Carpet | \$ 20.00 | 0.00 |
| FORM WORKER | \$ 11.87 | 0.00 |
| GLAZIER | \$ 19.12 | 4.41 |
| INSULATOR – BATT | \$ 14.87 | 0.73 |
| IRONWORKER, REINFORCING | \$ 12.10 | 0.00 |
| LABORER: Common or General | \$ 10.79 | 0.00 |
| LABORER: Mason Tender – Brick | \$ 13.37 | 0.00 |
| LABORER: Mason Tender Cement/Concrete | \$ 10.50 | 0.00 |
| LABORER: Pipe layer | \$ 12.94 | 0.00 |
| LABORER: Roof Tear off | \$ 11.28 | 0.00 |
| LABORER: Landscape and Irrigation | \$ 9.49 | 0.00 |
| LATHER | \$ 19.73 | 0.00 |
| OPERATOR Backhoe/Excavator/Trackhoe | \$ 14.10 | 0.00 |
| OPERATOR: Bobcat/Skid Steer/Skid Loader | \$ 13.93 | 0.00 |
| OPERATOR: Bulldozer | \$ 20.77 | 0.00 |
| OPERATOR: Drill | \$ 16.22 | 0.34 |
| OPERATOR: Forklift | \$ 15.64 | 0.00 |
| OPERATOR: Grader/Blade | \$ 13.37 | 0.00 |
| OPERATOR: Loader | \$ 13.55 | 0.94 |
| OPERATOR: Mechanic | \$ 17.52 | 3.33 |
| OPERATOR: Paver (Asphalt, Aggregate, and Concrete) | \$ 16.03 | 0.00 |
| OPERATOR: Roller | \$ 16.00 | 0.00 |
| PAINTER (Brush, Roller and Spray), Excludes Drywall Finishing/Taping | \$ 16.77 | 4.51 |
| ROOFER | \$ 15.40 | 0.00 |
| SHEET METAL WORKER (HVAC Duct Installation Only) | \$ 17.81 | 2.64 |
| SHEET METAL WORKER (HVAC Unit Installation Only) | \$ 16.00 | 1.61 |
| SPRINKLER FITTER (Fire Sprinklers) | \$ 22.17 | 9.70 |
| TILE FINISHER | \$ 12.00 | 0.00 |
| TILE SETTER | \$ 16.17 | 0.00 |
| TRUCK DRIVER: 1/Single Axle Truck | \$ 14.95 | 5.23 |
| TRUCK DRIVER: Dump Truck | \$ 12.39 | 1.18 |
| TRUCK DRIVER: Flatbed Truck | \$ 19.65 | 8.57 |

| | | |
|----------------------------------|----------|------|
| TRUCK DRIVER: Semi-Trailer Truck | \$ 12.50 | 0.00 |
| TRUCK DRIVER: Water Truck | \$ 12.00 | 4.11 |
| WATERPROOFER | \$ 14.39 | 0.00 |

WELDERS Receive rate prescribed for craft performing operation to which welding is incidental.

Note: Executive Order (EO) 13706, Establishing Paid Sick Leave for Federal Contractors applies to all contracts subject to the Davis-Bacon Act for which the contract is awarded (and any solicitation was issued) on or after January 1, 2017. If this contract is covered by the EO, the contractor must provide employees with 1 hour of paid sick leave for every 30 hours they work, up to 56 hours of paid sick leave each year. Employees must be permitted to use paid sick leave for their own illness, injury or other health-related needs, including preventive care; to assist a family member (or person who is like family to the employee) who is ill, injured, or has other health-related needs, including preventive care; or for reasons resulting from, or to assist a family member (or person who is like family to the employee) who is a victim of, domestic violence, sexual assault, or stalking. Additional information on contractor requirements and worker protections under the EO is available at www.dol.gov/whd/govcontracts.

Unlisted classifications needed for work not included within the scope of the classifications listed may be added after award only as provided in the labor standards contract clauses (29CFR 5.5 (a) (1) (ii)).

The body of each wage determination lists the classification and wage rates that have been found to be prevailing for the cited type(s) of construction in the area covered by the wage determination. The classifications are listed in alphabetical order of "identifiers" that indicate whether the particular rate is a union rate (current union negotiated rate for local), a survey rate (weighted average rate) or a union average rate (weighted union average rate).

Union Rate Identifiers

A four letter classification abbreviation identifier enclosed in dotted lines beginning with characters other than "SU" or "UAVG" denotes that the union classification and rate were prevailing for that classification in the survey. Example: PLUM0198-005 07/01/2014. PLUM is an abbreviation identifier of the union which prevailed in the survey for this classification, which in this example would be Plumbers. 0198 indicates the local union number or district council number where applicable, i.e., Plumbers Local 0198. The next number, 005 in the example, is an internal number used in processing the wage determination. 07/01/2014 is the effective date of the most current negotiated rate, which in this example is July 1, 2014.

Union prevailing wage rates are updated to reflect all rate changes in the collective bargaining agreement (CBA) governing this classification and rate.

Survey Rate Identifiers

Classifications listed under the "SU" identifier indicate that no one rate prevailed for this classification in the survey and the published rate is derived by computing a weighted average

rate based on all the rates reported in the survey for that classification. As this weighted average rate includes all rates reported in the survey, it may include both union and non-union rates. Example: SULA2012-007 5/13/2014. SU indicates the rates are survey rates based on a weighted average calculation of rates and are not majority rates. LA indicates the State of Louisiana. 2012 is the year of survey on which these classifications and rates are based. The next number, 007 in the example, is an internal number used in producing the wage determination. 5/13/2014 indicates the survey completion date for the classifications and rates under that identifier.

Survey wage rates are not updated and remain in effect until a new survey is conducted.

Union Average Rate Identifiers

Classification(s) listed under the UAVG identifier indicate that no single majority rate prevailed for those classifications; however, 100% of the data reported for the classifications was union data. EXAMPLE: UAVG-OH-0010 08/29/2014. UAVG indicates that the rate is a weighted union average rate. OH indicates the state. The next number, 0010 in the example, is an internal number used in producing the wage determination. 08/29/2014 indicates the survey completion date for the classifications and rates under that identifier.

A UAVG rate will be updated once a year, usually in January of each year, to reflect a weighted average of the current negotiated/CBA rate of the union locals from which the rate is based.

WAGE DETERMINATION APPEALS PROCESS

1.) Has there been an initial decision in the matter? This can be:

- * an existing published wage determination
- * a survey underlying a wage determination
- * a Wage and Hour Division letter setting forth a position on a wage determination matter
- * a conformance (additional classification and rate) ruling

On survey related matters, initial contact, including requests for summaries of surveys, should be with the Wage and Hour Regional Office for the area in which the survey was conducted because those Regional Offices have responsibility for the Davis-Bacon survey program. If the response from this initial contact is not satisfactory, then the process described in 2.) and 3.) should be followed. With regard to any other matter not yet ripe for the formal process described here, initial contact should be with the Branch of Construction Wage Determinations. Write to:

Branch of Construction Wage Determinations
Wage and Hour Division
U.S. Department of Labor
200 Constitution Avenue, N.W.
Washington, DC 20210

2.) If the answer to the question in 1.) is yes, then an interested party (those affected by the action) can request review and reconsideration from the Wage and Hour Administrator (See 29 CFR Part 1.8 and 29 CFR Part 7). Write to:

Wage and Hour Administrator
U.S. Department of Labor
200 Constitution Avenue, N.W.
Washington, DC 20210

The request should be accompanied by a full statement of the interested party's position and by any information (wage payment data, project description, area practice material, etc.) that the requestor considers relevant to the issue.

3.) If the decision of the Administrator is not favorable, an interested party may appeal directly to the Administrative Review Board (formerly the Wage Appeals Board). Write to:

Administrative Review Board
U.S. Department of Labor
200 Constitution Avenue, N.W.
Washington, DC 20210

4.) All decisions by the Administrative Review Board are final.

13.0 PERMITS:

It shall be the sole responsibility of the successful bidder to obtain all required permits in the name of Fort Bend County.

14.0 CONTRACTOR'S RESPONSIBILITY FOR WORK:

14.1 Preconstruction Work. Contractor shall do (or cause to be done) the following as preconstruction work:

14.1.1 On an as needed basis as determined by Fort Bend County, cause the Contractor's personnel to meet with Fort Bend County and the Engineer to discuss the status of the Project.

14.1.2 Review drawings and specifications with the Engineer to permit the Contractor and the Engineer to determine the compliance of the proposed facility with applicable building codes.

14.2 Construction Work. Contractor shall do (or cause to be done) the following as construction work:

14.2.1 Perform (or cause to be performed) all preparatory work at the construction site required herein, including (without limitation) soil and concrete testing and demolition of improvements existing at the construction site and all actions necessary for compliance with all laws and regulations as to actions to be taken by owners or contractors before construction begins, including without limitation those in regard to archaeological and environmental requirements.

- 14.2.2 Construct and install (or cause to be constructed and installed) the Project on the construction site in accordance with this Contract and the drawings and specifications approved by Fort Bend County.
- 14.2.3 Furnish (or cause to be furnished) all materials, supplies, equipment, tools, labor, supervision, utilities, transportation, and other materials and services necessary to complete the Project described herein.
- 14.2.4 Materials testing necessary for the Project and required by laws and regulations, construction industry standards as approved by Fort Bend County and this Contract; the frequency of testing shall be approved by Fort Bend County. **It is the contractor's responsibility to engage a material testing laboratory to perform testing on the structural concrete to be used for foundation work in this project. The cost of testing shall be incidental to bid item for drill shaft foundation. Testing of concrete shall comply with current TXDOT criteria. Contractor has to submit the name of the testing laboratory, intended to be used by the contractor for this project, for County's approval.**

14.3 Standards for Review and Approval.

- 14.3.1 Fort Bend County acknowledges that in order to meet the deadlines for the completion of the Project, and in order to accomplish the efficient completion of the Project, the Contractor may submit matters to Fort Bend County in stages for approval or consent. Upon receipt of any matter submitted by the Contractor for review and approval, Fort Bend County shall review the same and shall diligently and promptly (but in any event within 14 calendar days for any such matter, other than a proposed change order, and within 28 calendar days for a proposed change order) give the Contractor notice of Fort Bend County's approval or disapproval, setting forth in detail all reasons for any disapproval. Fort Bend County's right to disapprove any such matter submitted (other than a proposed change order) shall be limited to the elements thereof (a) which do not conform substantially to matters previously approved, (b) which are new elements not previously presented and approved and the Contractor is unable to demonstrate that such new element is reasonably necessary for completion of the Project, or (c) which depict matters that are violations of this Contract or applicable laws and regulations.
- 14.3.2 If Fort Bend County disapproves of a particular matter or Proposed Change Order, the Contractor shall have the right to resubmit such matter or Proposed Change Order to Fort Bend County, altered to satisfy Fort Bend County's basis for disapproval. Any resubmission shall be subject to review and approval by Fort Bend County.
- 14.3.3 Fort Bend County and the Contractor shall attempt in good faith to resolve

any disputes concerning the approval of any aspect of the Project expeditiously, so as not to delay the completion of the Project in accordance with this Contract.

14.3.4 Expedited Approvals. Fort Bend County recognizes the importance of expeditious action upon all matters submitted to Fort Bend County for review and approval and of expeditious response to those aspects of the Project requiring approval by governmental authorities having jurisdiction there over. Fort Bend County agrees to exercise its rights of review and approval hereunder with due diligence, reasonableness, and good faith. Fort Bend County shall use its reasonable efforts to expedite any required review of the Project or other matters by any governmental authority.

14.4 Changes.

14.4.1 General. Fort Bend County may make changes to the Project by altering, adding to, or deducting from the Project. All changes in the Project which (a) require an adjustment in the contract sum or an adjustment in the final completion date or (b) involve a material change in the overall scope or function of the Project shall be requested and authorized before commencing such changes by use of written change order notices, Proposed Change Orders and Change Orders, which change order procedure shall be the exclusive means to effect such changes in the Project.

14.4.2 Change Order Procedure. If at any time Fort Bend County desires to make any change in the Project requiring the issuance of a Change Order, Fort Bend County shall so advise the Contractor in writing by delivery to the Contractor of a written notice describing the change. Upon receipt of such notice initiated by Fort Bend County, the Contractor shall within a reasonable period of time advise Fort Bend County of the Contractor's proposal for the adjustments, if any, in the contract sum, the schedule of values, and the final completion date attributable to such change by delivering a written notice thereof (the "Proposed Change Order") to Fort Bend County. Such Proposed Change Order shall contain a description of the proposed change and shall set forth the Contractor's estimate of the increase or decrease, if any, in the contract sum and the change, if any, in the schedule of values and the final completion date attributable to such change. If the Contractor desires to make a change in the Project requiring the issuance of a change order, the Contractor shall deliver to Fort Bend County a Proposed Change Order. Upon execution by Fort Bend County, a Proposed Change Order shall constitute (and be defined herein as) a "Change Order" for purposes of this Contract. The Contractor shall forthwith perform the work as changed in accordance with such Change Order. All work performed pursuant to a Change Order shall be performed in accordance with the terms of this Contract. All Proposed Change Orders

shall be submitted for approval by Fort Bend County. No action, acquiescence or inaction by Fort Bend County or any representative of Fort Bend County shall be construed to be a waiver of requirements set forth in this Contract in regard to Change Orders or ratification of a violation of such requirements, and all acts in violation of this provision shall be considered void.

- 14.4.3 Change Order Authorization. Each Change Order shall be signed by Fort Bend County and an authorized representative of the Contractor.
- 14.4.4 Contract Sum Adjustments. The contract sum and the schedule of values shall be adjusted only as a result of a Change Order requiring such adjustment. Any extra work performed without a proper Change Order shall be considered voluntary and not subject to additional compensation. The Contractor shall not be entitled to an adjustment in the contract sum (or a Change Order permitting such adjustment) or to damages as a result of any delays in the Project caused by the acts or omissions of Fort Bend County, provided that this sentence is not applicable to delays that constitute more than 90 days in any 365-day period or cause the Project to be interrupted for a continuous period of 45 days through no fault of the Contractor.
- 14.4.5 When Fort Bend County and the Contractor agree upon the adjustments in the contract sum, the schedule of values, and the final completion date attributable to such adjustment, such agreement will be documented by preparation and if approved by the Fort Bend County Commissioners Court, execution of an appropriate Change Order.
- 14.5 Site Access. Prior to the transfer date, Fort Bend County and the Contractor shall have uninterrupted access to the construction site. Subsequent to the transfer date, Fort Bend County will permit the Contractor, the Engineer, and their representatives and subcontractors to enter upon the Project at times reasonably necessary to complete the punch list items.
- 14.6 Applicable Laws and Regulations. Contractor shall in its performance of the Project comply with all applicable laws and regulations. Any delays in the prosecution of the Project caused by any changes in the laws and regulations or the application or enforcement of the laws and regulations may entitle the Contractor to an extension of time.
- 14.7 Familiarity with Project. The Contractor represents and accepts that it has: (a) visited the property(ies), (b) taken such other steps as may be necessary to ascertain the nature and location of the Project and the general and local conditions which affect the Project or the cost thereof, (c) investigated the labor situation as regards to the Project, (d) examined the property(ies), the obstacles which may be encountered and all other observable conditions having a bearing upon the performance of the Project, the superintendence of the Project, the time

of completion and all other relevant matters, and (e) reported to Fort Bend County the results of all of the foregoing. The Contractor represents that it is familiar with all phases of the Project and the matters that may affect the Project or its prosecution under this Contract.

- 14.8 Standard of Performance. The Contractor shall prosecute (or cause to be prosecuted) the Project in accordance with the best efforts for the construction and development of projects similar to the Project in the State of Texas, using qualified, careful, and efficient contractors and workers and in conformity with the provisions of this Contract. The Contractor shall perform the work in a good and workmanlike manner.
- 14.9 Warranty of Contractor. The Contractor warrants to Fort Bend County that: (i) the Contractor possesses the skill and knowledge ordinarily possessed by well-informed members of its trade or profession and the Contractor will use its best efforts to ensure that the services provided under this Contract will be performed, delivered, and conducted in accordance with the best professional standards and in accordance with industry standards, and (ii) the Contractor is fully experienced and properly qualified to perform the class of work provided for herein, and that it is properly equipped, organized and financed to perform such work, and (iii) following the date of acceptance of this Contract, the services provided by the Contractor to Fort Bend County will conform to the representations contained in this Contract, including all attachments, schedules and exhibits. All warranties provided by the Contractor in this Contract shall be cumulative, shall be deemed consistent and not in conflict, are intended to be given full force and effect and to be interpreted expansively to give the broadest warranty protection to Fort Bend County.
- 14.10 Contractor's Personnel. Contractor shall employ only competent, skilled personnel for the Project. Prior to the final completion date, the Contractor shall maintain a superintendent who shall be authorized to act on behalf of the Contractor and with whom Fort Bend County may consult at all reasonable times. The superintendent shall not be transferred from the Project without Fort Bend County's consent (which shall not be unreasonably withheld or delayed); provided, however, the superintendent shall not be assigned solely to the Project and shall be entitled to spend reasonable time working on matters unrelated to the Project so long as such work on other matters does not render the superintendent unavailable to the Project or unavailable to Fort Bend County. However, such obligation to furnish the superintendent and such staff personnel shall not be construed (a) to preclude the promotion within the Contractor's organization of any person assigned to the Project or (b) to give rise to any liability of the Contractor if any person assigned to the Project (including, without limitation, the superintendent) leaves the Contractor's employment. If the superintendent is transferred from the Project, Fort Bend County shall have the right to approve the replacement superintendent (which approval will not be unreasonably withheld or delayed). The Contractor, the Architect, and the other subcontractors shall comply with all applicable health,

safety, and loss prevention rules of applicable governmental authorities. The Contractor shall, at its own expense, remove from the Project any person who fails to comply with such rules and instructions. The Contractor shall at all times enforce strict discipline and good order among its employees and shall not employ on the Project any unfit person or anyone not skilled in the work assigned to him. Fort Bend County may, upon written notice to the Contractor, require the Contractor to remove an individual immediately from providing services for the following reasons: violation of the terms and conditions of this Contract; violation of Fort Bend County's or the Contractor's work rules and regulations; criminal activity; or violation of state, federal, or municipal statutes. Fort Bend County may, upon thirty (30) days written notice to the Contractor, require the removal of any individual from providing services without cause.

- 14.11 Inspection. The Project and all parts thereof shall be subject to inspection from time to time by inspectors designated by Fort Bend County. No such inspections shall relieve The Contractor of any of its obligations hereunder. Neither failure to inspect nor failure to discover or reject any of the work as not in accordance with the drawings and specifications or any provision of this Contract shall be construed to imply an acceptance of such work or to relieve the Contractor of any of its obligations hereunder. Fort Bend County agrees that its right of inspection shall be used reasonably and in a timely manner so as not to delay orderly completion of the Project.
- 14.12 Protection Against Risks. The Contractor shall take all precautions which are necessary and adequate, against conditions created during the progress of the Project which involve a risk of bodily harm to persons or a risk of damage or loss to any property. The Contractor shall regularly inspect all work, materials and equipment to discover and determine any such conditions and shall be responsible for discovery, determination, and correction of any such conditions. The Contractor shall comply with all federal, state, and local occupational hazard and safety standards, codes and regulations applicable in the jurisdiction where the Project is being performed. The Contractor shall include the substance of this clause in its entirety in all subcontracts for any work to be performed at the construction site.
- 14.13 Equipment. Except as expressly provided herein to the contrary, the Contractor shall furnish (or cause to be furnished) all construction, transportation, installation, tools, and other equipment and facilities required for the performance of the Project within the times specified herein. Such equipment and facilities shall be serviceable and kept fit for the uses intended. Defective items shall be removed from the construction site promptly and at the Contractor's cost. The Contractor shall schedule (or cause to be scheduled) its other operations so as to not interfere with its duty to timely furnish the necessary equipment and facilities and personnel to operate the same at the times necessary for the orderly completion of the Project.

14.14 Materials. Except as may be specifically provided otherwise in the Contract or approved in advance by Fort Bend County, the Contractor shall provide Fort Bend County with copies of material testing reports and to cause all materials, equipment, and fabricated items incorporated in the Project to be new and of a suitable grade of their respective kinds for their intended use.

15.0 TERMINATION:

15.1 Fort Bend County may terminate the Contract if the Contractor:

15.1.1 Persistently or repeatedly refuses or fails to supply enough properly skilled workers or proper materials.

15.1.2 Fails to make payment to Subcontractors for materials or labor in accordance with the respective agreements between the Contractor and the Subcontractor.

15.1.3 Persistently disregards laws, ordinances, or rules, regulations or orders of a public authority having jurisdiction.

15.1.4 Otherwise is guilty of substantial breach of a provision of the Contract Documents.

15.2 When any of the above reasons exists, Fort Bend County may, without prejudice to any other rights or remedies of Fort Bend County and after giving the Contractor and the Contractor's surety, if any, seven days' written notice, terminate employment of the Contractor and may, subject to any prior rights of the surety:

15.2.1 Take possession of the site and of all materials, equipment, tools, and construction equipment and machinery thereon owned by the Contractor.

15.2.2 Finish the Project by whatever reasonable method Fort Bend County may deem expedient.

15.3 Either party may terminate this Contract at any time by providing thirty (30) days written notice.

15.4 When Fort Bend County terminates the Contract for one of the reasons stated in this section, the Contractor shall not be entitled to receive further payment until the Project is finished. Therefore, the Contractor shall be promptly paid for all work actually and satisfactorily completed.

16.0 COMPLETION, TRANSFER, AND ACCEPTANCE:

16.1 Final Completion. Upon the occurrence of the final completion date, the punch list items shall be promptly commenced and thereafter completed within thirty (30) days after final completion.

16.2 Transfer and Acceptance. Upon the occurrence of final completion, care, custody and control of the Project shall pass to Fort Bend County. As referenced herein, the "Transfer Date" shall mean the date on which the care, custody and control of the Project passes to Fort Bend County. Subsequent to the Transfer Date all risk of loss with respect to the Project shall be by Fort Bend County and the Contractor shall be thereafter obligated to cover the Project with their Insurance.

17.0 SUSPENSION BY FORT BEND COUNTY FOR CONVENIENCE:

17.1 Fort Bend County may, without cause, order the Contractor in writing to suspend, delay or interrupt the Project in whole or in part for such period of time as Fort Bend County may determine.

17.2 An adjustment shall be made for increase in the cost of performance, caused by suspension, delay or interruption. No adjustment shall be made to the extent:

17.2.1 That performance is, was or would have been so suspended, delayed or interrupted by another cause for which the Contractor is responsible.

17.2.2 That an equitable adjustment is made or denied under another provision of this Contract.

17.3 Adjustments made in the cost of performance may have a mutually agreed fixed or percentage fee.

18.0 INDEPENDENT CONTRACTOR:

The Contractor shall be an independent contractor and any provisions of this Contract that may appear to give Fort Bend County the right to direct the Contractor as to the details of the manner of doing the Project shall be deemed to mean that the Contractor shall follow the desires of Fort Bend County in the results of the Project only and not in the means whereby the Project is to be accomplished. The Contractor shall be responsible as to the details of completing the Project. Neither the agents, representatives, nor employees of the Contractor, shall be deemed to be the agents, representatives, or employees of Fort Bend County. The Contractor further represents that it accepts a fiduciary role and responsibility with respect to Fort Bend County and will, to its best abilities, act in the best interests of Fort Bend County and the timely completion of the Project. The Contractor agrees and understands that neither it nor any of its agents or employees may act in the name of Fort Bend County except and unless specifically authorized in writing by Fort Bend County to do so. The Contractor shall furnish construction administration and management services and use the Contractor's best efforts to complete the Project in an

expeditious and economical manner consistent with the interests of Fort Bend County.

19.0 NOTICE

- 19.1 All written notices, demands, and other papers or documents to be delivered to Fort Bend County under this Contract shall be delivered to the Facilities Department, 301 Jackson, Richmond, Texas 77469, or at such other place or places as Fort Bend County may from time to time designate by written notice delivered to the Contractor. For purposes of notice under this Contract, a copy of any notice or communication hereunder shall also be forwarded to the following address: Fort Bend County, 301 Jackson Street, Suite 719, Richmond, Texas 77469, Attention: County Judge.
- 19.2 All written notices, demands, and other papers or documents to be delivered to the Contractor under this Contract shall be delivered to the Authorized Representative identified in the Contract documents or such other place or places as the Contractor may designate by written notice delivered to Fort Bend County.

20.0 RECORDS:

- 20.1 Fort Bend County shall be the absolute and unqualified owner of all drawings, preliminary layouts, record drawings, sketches and other documents prepared pursuant to the Contract by Contractor.
- 20.2 The Contractor agrees to maintain and preserve for a period of at least five years after the earlier of the expiration of the defects period or termination of this Contract, accurate and complete records relating to the performance of the Project. The Contractor agrees to, upon request, provide Fort Bend County with such records.

21.0 SUCCESSORS AND ASSIGNS:

- 21.1 Fort Bend County and the Contractor bind themselves and their successors, executors, administrators and assigns to the other party of this Contract and to the successors, executors, administrators and assigns of such other party, in respect to all covenants of this Contract.
- 21.2 Neither Fort Bend County nor the Contractor shall assign, sublet or transfer its interest in this Contract without the prior written consent of the other.
- 21.3 Nothing herein shall be construed as creating any personal liability on the part of any officer or agent of any public and/or governmental body that may be a party hereto.

22.0 PUBLIC CONTACT:

Contact with the news media, citizens of Fort Bend County or governmental agencies shall be the sole responsibility of Fort Bend County. Under no circumstances, whatsoever, shall

Contractor release any material or information developed in the performance of its services hereunder without the express written permission of Fort Bend County, except where required to do so by law.

23.0 MODIFICATIONS:

This instrument contains the entire Contract between the parties relating to the rights herein granted and obligations herein assumed. Any oral or written representations or modifications concerning this instrument shall be of no force and effect excepting a subsequent written modification signed by both parties hereto.

24.0 SILENCE OF SPECIFICATIONS:

The apparent silence of specifications as to any detail, or the apparent omission from it of a detailed description concerning any point, shall be regarded as meaning that only the best commercial practice is to prevail and that only material and workmanship of the finest quality are to be used. All interpretations of specifications shall be made on the basis of this statement. The items furnished under this contract shall be new, unused of the latest product in production to commercial trade and shall be of the highest quality as to materials used and workmanship. Manufacturer furnishing these items shall be experienced in design and construction of such items and shall be an established supplier of the item bid.

25.0 SEVERABILITY:

In the event one or more of the provisions contained in these requirements or the specifications shall for any reason be held to be invalid, illegal or unenforceable in any respect, such invalidity, illegality, or unenforceability shall not affect any other provision hereof and these requirements or the specifications shall be construed as if such invalid, illegal, or unenforceable provision had never been contained herein.

26.0 GOVERNING FORMS:

In the event of any conflict between the terms and provisions of these requirements and the specifications, the specifications shall govern. In the event of any conflict of interpretation of any part of this overall document, Fort Bend County's interpretation shall govern.

27.0 TAX EXEMPT:

Fort Bend County is exempt from state and local sales and use taxes under Section 151.309 of the Texas Tax Code. This Contract is deemed to be a separate contract for Texas tax purposes, and as such, Fort Bend County hereby issues its Texas Exemption for the purchase of any items qualifying for exemption under this Contract. Contractor is to issue its Texas Resale Certificate to vendors and subcontractors for such items qualifying for this exemption, and further, contractor should state these items at cost.

28.0 ENTIRE AGREEMENT:

The Parties agree that this Contract contains all of the terms and conditions of the understanding of the parties relating to the subject matter hereof. All prior negotiations, discussions, correspondence and preliminary understandings between the parties and others relating hereto are superseded by this Contract. By entering into this Contract, the parties do not intend to create any obligations, express or implied, other than those specifically set out in this Contract.

29.0 APPLICABLE LAW AND VENUE

This Contract shall be construed under and in accord with the laws of the State of Texas, and all obligations of the parties created hereunder are performable in Fort Bend County, Texas, and that venue for any litigation arising out of or related to this Contract shall lie solely in the court of appropriate jurisdiction located in Fort Bend County, Texas.

30.0 REQUIRED LICENSING: Vendor must have a current plumbing license by the State of Texas. Proof of such licensing must accompany Vendor's bid submission.

31.0 PRICING:

31.1 Hot Water Distribution Repairs: \$ _____

32.0 PROJECT DURATION:

Bidder agrees, if awarded the contract, to complete all work required by the contract documents **within _____ calendar days** after issuance of a purchase order by the County Purchasing Agent and notice to proceed by the Facilities Department.

33.0 AWARD:

This contract will be awarded to the lowest and best bid.

34.0 TEXAS ETHICS COMMISSION FORM 1295:

34.1 Effective January 1, 2016 all contracts executed by Commissioners Court, regardless of the dollar amount, will require completion of Form 1295 "Certificate of Interested Parties", per the new Government Code Statute §2252.908. All vendors submitting a response to a formal Bid, RFP, SOQ or any contracts, contract amendments, renewals or change orders are required to complete the Form 1295 online through the State of Texas Ethics Commission website. Please visit:

https://www.ethics.state.tx.us/whatsnew/elf_info_form1295.htm.

34.2 On-line instructions:

34.2.1 Name of governmental entity is to read Fort Bend County

34.2.2 Identification number used by the governmental entity is: B18-078

34.2.3 Description is the title of the solicitation: Hot Water Distribution Repairs at the Fort Bend County West Tower Jail

34.3 Apparent low bidder(s) will be required to provide the Form 1295 within three (3) calendar days from notification; however, if your company is publicly traded you are not required to complete this form.

35.0 STATE LAW REQUIREMENTS FOR CONTRACTS:

The contents of this section are required by Texas Law and are included by County regardless of content.

35.1 Agreement to Not Boycott Israel Chapter 2270 Texas Government Code: By signature on vendor form, Contractor verifies Contractor does not boycott Israel and will not boycott Israel during the term of this Contract.

35.2 Texas Government Code Section 2251.152 Acknowledgment: By signature on vendor form, Contractor represents pursuant to Section 2252.152 of the Texas Government Code, that Contractor is not listed on the website of the Comptroller of the State of Texas concerning the listing of companies that are identified under Section 806.051, Section 807.051 or Section 2253.153.

36.0 REQUIRED FORMS:

All vendors submitting are required to complete the attached and return with submission:

36.1 Vendor Form

36.2 W9 Form

36.3 Tax Form/Debt/Residence Certification

36.4 Contractor Acknowledgement of Stormwater Management Program

37.0 ENCLOSURES:

37.1 Plans with specifications

**Contract Sheet
Bid 18-078**

**THE STATE OF TEXAS
COUNTY OF FORT BEND**

This memorandum of agreement made and entered into on the _____ day of _____, 20____, by and between Fort Bend County in the State of Texas (hereinafter designated County), acting herein by County Judge Robert Hebert, by virtue of an order of Fort Bend County Commissioners Court, and _____
(company name)
(hereinafter designated Contractor).

WITNESSETH:

The Contractor and the County agree that the bid and specifications for the **Hot Water Distribution Repairs at the Fort Bend County West Tower Jail** which are hereto attached and made a part hereof, together with this instrument and the bond (when required) shall constitute the full agreement and contract between parties and for furnishing the items set out and described; the County agrees to pay the prices stipulated in the accepted bid.

It is further agreed that this contract shall not become binding or effective until signed by the parties hereto and a purchase order authorizing the items desired has been issued.

Executed at Richmond, Texas this _____ day of _____ 20_____.

Fort Bend County, Texas

By: _____
County Judge, **Robert Hebert**

By: _____
Signature of Contractor

By: _____
Printed Name and Title

Request for Taxpayer Identification Number and Certification

**Give Form to the
 requester. Do not
 send to the IRS.**

| | | |
|---|--|--|
| Print or type See Specific Instructions on page 2. | 1 Name (as shown on your income tax return). Name is required on this line; do not leave this line blank. | |
| | 2 Business name/disregarded entity name, if different from above | |
| | 3 Check appropriate box for federal tax classification; check only one of the following seven boxes: <input type="checkbox"/> Individual/sole proprietor or single-member LLC <input type="checkbox"/> C Corporation <input type="checkbox"/> S Corporation <input type="checkbox"/> Partnership <input type="checkbox"/> Trust/estate <input type="checkbox"/> Limited liability company. Enter the tax classification (C=C corporation, S=S corporation, P=partnership) ▶ _____ Note. For a single-member LLC that is disregarded, do not check LLC; check the appropriate box in the line above for the tax classification of the single-member owner. <input type="checkbox"/> Other (see instructions) ▶ _____ | 4 Exemptions (codes apply only to certain entities, not individuals; see instructions on page 3): Exempt payee code (if any) _____ Exemption from FATCA reporting code (if any) _____ <i>(Applies to accounts maintained outside the U.S.)</i> |
| | 5 Address (number, street, and apt. or suite no.) | Requester's name and address (optional) |
| | 6 City, state, and ZIP code | |
| | 7 List account number(s) here (optional) | |

Part I Taxpayer Identification Number (TIN)

Enter your TIN in the appropriate box. The TIN provided must match the name given on line 1 to avoid backup withholding. For individuals, this is generally your social security number (SSN). However, for a resident alien, sole proprietor, or disregarded entity, see the Part I instructions on page 3. For other entities, it is your employer identification number (EIN). If you do not have a number, see *How to get a TIN* on page 3.

Note. If the account is in more than one name, see the instructions for line 1 and the chart on page 4 for guidelines on whose number to enter.

| | | | | | | | | | |
|---------------------------------------|--|--|--|---|--|--|---|--|--|
| Social security number | | | | | | | | | |
| | | | | - | | | - | | |
| or | | | | | | | | | |
| Employer identification number | | | | | | | | | |
| | | | | - | | | | | |

Part II Certification

Under penalties of perjury, I certify that:

1. The number shown on this form is my correct taxpayer identification number (or I am waiting for a number to be issued to me); and
2. I am not subject to backup withholding because: (a) I am exempt from backup withholding, or (b) I have not been notified by the Internal Revenue Service (IRS) that I am subject to backup withholding as a result of a failure to report all interest or dividends, or (c) the IRS has notified me that I am no longer subject to backup withholding; and
3. I am a U.S. citizen or other U.S. person (defined below); and
4. The FATCA code(s) entered on this form (if any) indicating that I am exempt from FATCA reporting is correct.

Certification instructions. You must cross out item 2 above if you have been notified by the IRS that you are currently subject to backup withholding because you have failed to report all interest and dividends on your tax return. For real estate transactions, item 2 does not apply. For mortgage interest paid, acquisition or abandonment of secured property, cancellation of debt, contributions to an individual retirement arrangement (IRA), and generally, payments other than interest and dividends, you are not required to sign the certification, but you must provide your correct TIN. See the instructions on page 3.

| | | |
|------------------|----------------------------|--------|
| Sign Here | Signature of U.S. person ▶ | Date ▶ |
|------------------|----------------------------|--------|

General Instructions

Section references are to the Internal Revenue Code unless otherwise noted.

Future developments. Information about developments affecting Form W-9 (such as legislation enacted after we release it) is at www.irs.gov/fw9.

Purpose of Form

An individual or entity (Form W-9 requester) who is required to file an information return with the IRS must obtain your correct taxpayer identification number (TIN) which may be your social security number (SSN), individual taxpayer identification number (ITIN), adoption taxpayer identification number (ATIN), or employer identification number (EIN), to report on an information return the amount paid to you, or other amount reportable on an information return. Examples of information returns include, but are not limited to, the following:

- Form 1099-INT (interest earned or paid)
- Form 1099-DIV (dividends, including those from stocks or mutual funds)
- Form 1099-MISC (various types of income, prizes, awards, or gross proceeds)
- Form 1099-B (stock or mutual fund sales and certain other transactions by brokers)
- Form 1099-S (proceeds from real estate transactions)
- Form 1099-K (merchant card and third party network transactions)

- Form 1098 (home mortgage interest), 1098-E (student loan interest), 1098-T (tuition)
- Form 1099-C (canceled debt)
- Form 1099-A (acquisition or abandonment of secured property)

Use Form W-9 only if you are a U.S. person (including a resident alien), to provide your correct TIN.

If you do not return Form W-9 to the requester with a TIN, you might be subject to backup withholding. See What is backup withholding? on page 2.

By signing the filled-out form, you:

1. Certify that the TIN you are giving is correct (or you are waiting for a number to be issued),
2. Certify that you are not subject to backup withholding, or
3. Claim exemption from backup withholding if you are a U.S. exempt payee. If applicable, you are also certifying that as a U.S. person, your allocable share of any partnership income from a U.S. trade or business is not subject to the withholding tax on foreign partners' share of effectively connected income, and
4. Certify that FATCA code(s) entered on this form (if any) indicating that you are exempt from the FATCA reporting, is correct. See *What is FATCA reporting?* on page 2 for further information.

Note. If you are a U.S. person and a requester gives you a form other than Form W-9 to request your TIN, you must use the requester's form if it is substantially similar to this Form W-9.

Definition of a U.S. person. For federal tax purposes, you are considered a U.S. person if you are:

- An individual who is a U.S. citizen or U.S. resident alien;
- A partnership, corporation, company, or association created or organized in the United States or under the laws of the United States;
- An estate (other than a foreign estate); or
- A domestic trust (as defined in Regulations section 301.7701-7).

Special rules for partnerships. Partnerships that conduct a trade or business in the United States are generally required to pay a withholding tax under section 1446 on any foreign partners' share of effectively connected taxable income from such business. Further, in certain cases where a Form W-9 has not been received, the rules under section 1446 require a partnership to presume that a partner is a foreign person, and pay the section 1446 withholding tax. Therefore, if you are a U.S. person that is a partner in a partnership conducting a trade or business in the United States, provide Form W-9 to the partnership to establish your U.S. status and avoid section 1446 withholding on your share of partnership income.

In the cases below, the following person must give Form W-9 to the partnership for purposes of establishing its U.S. status and avoiding withholding on its allocable share of net income from the partnership conducting a trade or business in the United States:

- In the case of a disregarded entity with a U.S. owner, the U.S. owner of the disregarded entity and not the entity;
- In the case of a grantor trust with a U.S. grantor or other U.S. owner, generally, the U.S. grantor or other U.S. owner of the grantor trust and not the trust; and
- In the case of a U.S. trust (other than a grantor trust), the U.S. trust (other than a grantor trust) and not the beneficiaries of the trust.

Foreign person. If you are a foreign person or the U.S. branch of a foreign bank that has elected to be treated as a U.S. person, do not use Form W-9. Instead, use the appropriate Form W-8 or Form 8233 (see Publication 515, Withholding of Tax on Nonresident Aliens and Foreign Entities).

Nonresident alien who becomes a resident alien. Generally, only a nonresident alien individual may use the terms of a tax treaty to reduce or eliminate U.S. tax on certain types of income. However, most tax treaties contain a provision known as a "saving clause." Exceptions specified in the saving clause may permit an exemption from tax to continue for certain types of income even after the payee has otherwise become a U.S. resident alien for tax purposes.

If you are a U.S. resident alien who is relying on an exception contained in the saving clause of a tax treaty to claim an exemption from U.S. tax on certain types of income, you must attach a statement to Form W-9 that specifies the following five items:

1. The treaty country. Generally, this must be the same treaty under which you claimed exemption from tax as a nonresident alien.
2. The treaty article addressing the income.
3. The article number (or location) in the tax treaty that contains the saving clause and its exceptions.
4. The type and amount of income that qualifies for the exemption from tax.
5. Sufficient facts to justify the exemption from tax under the terms of the treaty article.

Example. Article 20 of the U.S.-China income tax treaty allows an exemption from tax for scholarship income received by a Chinese student temporarily present in the United States. Under U.S. law, this student will become a resident alien for tax purposes if his or her stay in the United States exceeds 5 calendar years. However, paragraph 2 of the first Protocol to the U.S.-China treaty (dated April 30, 1984) allows the provisions of Article 20 to continue to apply even after the Chinese student becomes a resident alien of the United States. A Chinese student who qualifies for this exception (under paragraph 2 of the first protocol) and is relying on this exception to claim an exemption from tax on his or her scholarship or fellowship income would attach to Form W-9 a statement that includes the information described above to support that exemption.

If you are a nonresident alien or a foreign entity, give the requester the appropriate completed Form W-8 or Form 8233.

Backup Withholding

What is backup withholding? Persons making certain payments to you must under certain conditions withhold and pay to the IRS 28% of such payments. This is called "backup withholding." Payments that may be subject to backup withholding include interest, tax-exempt interest, dividends, broker and barter exchange transactions, rents, royalties, nonemployee pay, payments made in settlement of payment card and third party network transactions, and certain payments from fishing boat operators. Real estate transactions are not subject to backup withholding.

You will not be subject to backup withholding on payments you receive if you give the requester your correct TIN, make the proper certifications, and report all your taxable interest and dividends on your tax return.

Payments you receive will be subject to backup withholding if:

1. You do not furnish your TIN to the requester,
2. You do not certify your TIN when required (see the Part II instructions on page 3 for details),

3. The IRS tells the requester that you furnished an incorrect TIN,

4. The IRS tells you that you are subject to backup withholding because you did not report all your interest and dividends on your tax return (for reportable interest and dividends only), or

5. You do not certify to the requester that you are not subject to backup withholding under 4 above (for reportable interest and dividend accounts opened after 1983 only).

Certain payees and payments are exempt from backup withholding. See *Exempt payee code* on page 3 and the separate Instructions for the Requester of Form W-9 for more information.

Also see *Special rules for partnerships* above.

What is FATCA reporting?

The Foreign Account Tax Compliance Act (FATCA) requires a participating foreign financial institution to report all United States account holders that are specified United States persons. Certain payees are exempt from FATCA reporting. See *Exemption from FATCA reporting code* on page 3 and the Instructions for the Requester of Form W-9 for more information.

Updating Your Information

You must provide updated information to any person to whom you claimed to be an exempt payee if you are no longer an exempt payee and anticipate receiving reportable payments in the future from this person. For example, you may need to provide updated information if you are a C corporation that elects to be an S corporation, or if you no longer are tax exempt. In addition, you must furnish a new Form W-9 if the name or TIN changes for the account; for example, if the grantor of a grantor trust dies.

Penalties

Failure to furnish TIN. If you fail to furnish your correct TIN to a requester, you are subject to a penalty of \$50 for each such failure unless your failure is due to reasonable cause and not to willful neglect.

Civil penalty for false information with respect to withholding. If you make a false statement with no reasonable basis that results in no backup withholding, you are subject to a \$500 penalty.

Criminal penalty for falsifying information. Willfully falsifying certifications or affirmations may subject you to criminal penalties including fines and/or imprisonment.

Misuse of TINs. If the requester discloses or uses TINs in violation of federal law, the requester may be subject to civil and criminal penalties.

Specific Instructions

Line 1

You must enter one of the following on this line; **do not** leave this line blank. The name should match the name on your tax return.

If this Form W-9 is for a joint account, list first, and then circle, the name of the person or entity whose number you entered in Part I of Form W-9.

a. **Individual.** Generally, enter the name shown on your tax return. If you have changed your last name without informing the Social Security Administration (SSA) of the name change, enter your first name, the last name as shown on your social security card, and your new last name.

Note. ITIN applicant: Enter your individual name as it was entered on your Form W-7 application, line 1a. This should also be the same as the name you entered on the Form 1040/1040A/1040EZ you filed with your application.

b. **Sole proprietor or single-member LLC.** Enter your individual name as shown on your 1040/1040A/1040EZ on line 1. You may enter your business, trade, or "doing business as" (DBA) name on line 2.

c. **Partnership, LLC that is not a single-member LLC, C Corporation, or S Corporation.** Enter the entity's name as shown on the entity's tax return on line 1 and any business, trade, or DBA name on line 2.

d. **Other entities.** Enter your name as shown on required U.S. federal tax documents on line 1. This name should match the name shown on the charter or other legal document creating the entity. You may enter any business, trade, or DBA name on line 2.

e. **Disregarded entity.** For U.S. federal tax purposes, an entity that is disregarded as an entity separate from its owner is treated as a "disregarded entity." See Regulations section 301.7701-2(c)(2)(iii). Enter the owner's name on line 1. The name of the entity entered on line 1 should never be a disregarded entity. The name on line 1 should be the name shown on the income tax return on which the income should be reported. For example, if a foreign LLC that is treated as a disregarded entity for U.S. federal tax purposes has a single owner that is a U.S. person, the U.S. owner's name is required to be provided on line 1. If the direct owner of the entity is also a disregarded entity, enter the first owner that is not disregarded for federal tax purposes. Enter the disregarded entity's name on line 2, "Business name/disregarded entity name." If the owner of the disregarded entity is a foreign person, the owner must complete an appropriate Form W-8 instead of a Form W-9. This is the case even if the foreign person has a U.S. TIN.

Line 2

If you have a business name, trade name, DBA name, or disregarded entity name, you may enter it on line 2.

Line 3

Check the appropriate box in line 3 for the U.S. federal tax classification of the person whose name is entered on line 1. Check only one box in line 3.

Limited Liability Company (LLC). If the name on line 1 is an LLC treated as a partnership for U.S. federal tax purposes, check the "Limited Liability Company" box and enter "P" in the space provided. If the LLC has filed Form 8832 or 2553 to be taxed as a corporation, check the "Limited Liability Company" box and in the space provided enter "C" for C corporation or "S" for S corporation. If it is a single-member LLC that is a disregarded entity, do not check the "Limited Liability Company" box; instead check the first box in line 3 "Individual/sole proprietor or single-member LLC."

Line 4, Exemptions

If you are exempt from backup withholding and/or FATCA reporting, enter in the appropriate space in line 4 any code(s) that may apply to you.

Exempt payee code.

- Generally, individuals (including sole proprietors) are not exempt from backup withholding.
- Except as provided below, corporations are exempt from backup withholding for certain payments, including interest and dividends.
- Corporations are not exempt from backup withholding for payments made in settlement of payment card or third party network transactions.
- Corporations are not exempt from backup withholding with respect to attorneys' fees or gross proceeds paid to attorneys, and corporations that provide medical or health care services are not exempt with respect to payments reportable on Form 1099-MISC.

The following codes identify payees that are exempt from backup withholding. Enter the appropriate code in the space in line 4.

- 1—An organization exempt from tax under section 501(a), any IRA, or a custodial account under section 403(b)(7) if the account satisfies the requirements of section 401(f)(2)
- 2—The United States or any of its agencies or instrumentalities
- 3—A state, the District of Columbia, a U.S. commonwealth or possession, or any of their political subdivisions or instrumentalities
- 4—A foreign government or any of its political subdivisions, agencies, or instrumentalities
- 5—A corporation
- 6—A dealer in securities or commodities required to register in the United States, the District of Columbia, or a U.S. commonwealth or possession
- 7—A futures commission merchant registered with the Commodity Futures Trading Commission
- 8—A real estate investment trust
- 9—An entity registered at all times during the tax year under the Investment Company Act of 1940
- 10—A common trust fund operated by a bank under section 584(a)
- 11—A financial institution
- 12—A middleman known in the investment community as a nominee or custodian
- 13—A trust exempt from tax under section 664 or described in section 4947

The following chart shows types of payments that may be exempt from backup withholding. The chart applies to the exempt payees listed above, 1 through 13.

| IF the payment is for . . . | THEN the payment is exempt for . . . |
|--|---|
| Interest and dividend payments | All exempt payees except for 7 |
| Broker transactions | Exempt payees 1 through 4 and 6 through 11 and all C corporations. S corporations must not enter an exempt payee code because they are exempt only for sales of noncovered securities acquired prior to 2012. |
| Barter exchange transactions and patronage dividends | Exempt payees 1 through 4 |
| Payments over \$600 required to be reported and direct sales over \$5,000 ¹ | Generally, exempt payees 1 through 5 ² |
| Payments made in settlement of payment card or third party network transactions | Exempt payees 1 through 4 |

¹ See Form 1099-MISC, Miscellaneous Income, and its instructions.

² However, the following payments made to a corporation and reportable on Form 1099-MISC are not exempt from backup withholding: medical and health care payments, attorneys' fees, gross proceeds paid to an attorney reportable under section 6045(f), and payments for services paid by a federal executive agency.

Exemption from FATCA reporting code. The following codes identify payees that are exempt from reporting under FATCA. These codes apply to persons submitting this form for accounts maintained outside of the United States by certain foreign financial institutions. Therefore, if you are only submitting this form for an account you hold in the United States, you may leave this field blank. Consult with the person requesting this form if you are uncertain if the financial institution is subject to these requirements. A requester may indicate that a code is not required by providing you with a Form W-9 with "Not Applicable" (or any similar indication) written or printed on the line for a FATCA exemption code.

A—An organization exempt from tax under section 501(a) or any individual retirement plan as defined in section 7701(a)(37)

B—The United States or any of its agencies or instrumentalities

C—A state, the District of Columbia, a U.S. commonwealth or possession, or any of their political subdivisions or instrumentalities

D—A corporation the stock of which is regularly traded on one or more established securities markets, as described in Regulations section 1.1472-1(c)(1)(i)

E—A corporation that is a member of the same expanded affiliated group as a corporation described in Regulations section 1.1472-1(c)(1)(i)

F—A dealer in securities, commodities, or derivative financial instruments (including notional principal contracts, futures, forwards, and options) that is registered as such under the laws of the United States or any state

G—A real estate investment trust

H—A regulated investment company as defined in section 851 or an entity registered at all times during the tax year under the Investment Company Act of 1940

I—A common trust fund as defined in section 584(a)

J—A bank as defined in section 581

K—A broker

L—A trust exempt from tax under section 664 or described in section 4947(a)(1)

M—A tax exempt trust under a section 403(b) plan or section 457(g) plan

Note. You may wish to consult with the financial institution requesting this form to determine whether the FATCA code and/or exempt payee code should be completed.

Line 5

Enter your address (number, street, and apartment or suite number). This is where the requester of this Form W-9 will mail your information returns.

Line 6

Enter your city, state, and ZIP code.

Part I. Taxpayer Identification Number (TIN)

Enter your TIN in the appropriate box. If you are a resident alien and you do not have and are not eligible to get an SSN, your TIN is your IRS individual taxpayer identification number (ITIN). Enter it in the social security number box. If you do not have an ITIN, see *How to get a TIN* below.

If you are a sole proprietor and you have an EIN, you may enter either your SSN or EIN. However, the IRS prefers that you use your SSN.

If you are a single-member LLC that is disregarded as an entity separate from its owner (see *Limited Liability Company (LLC)* on this page), enter the owner's SSN (or EIN, if the owner has one). Do not enter the disregarded entity's EIN. If the LLC is classified as a corporation or partnership, enter the entity's EIN.

Note. See the chart on page 4 for further clarification of name and TIN combinations.

How to get a TIN. If you do not have a TIN, apply for one immediately. To apply for an SSN, get Form SS-5, Application for a Social Security Card, from your local SSA office or get this form online at www.ssa.gov. You may also get this form by calling 1-800-772-1213. Use Form W-7, Application for IRS Individual Taxpayer Identification Number, to apply for an ITIN, or Form SS-4, Application for Employer Identification Number, to apply for an EIN. You can apply for an EIN online by accessing the IRS website at www.irs.gov/businesses and clicking on Employer Identification Number (EIN) under Starting a Business. You can get Forms W-7 and SS-4 from the IRS by visiting IRS.gov or by calling 1-800-TAX-FORM (1-800-829-3676).

If you are asked to complete Form W-9 but do not have a TIN, apply for a TIN and write "Applied For" in the space for the TIN, sign and date the form, and give it to the requester. For interest and dividend payments, and certain payments made with respect to readily tradable instruments, generally you will have 60 days to get a TIN and give it to the requester before you are subject to backup withholding on payments. The 60-day rule does not apply to other types of payments. You will be subject to backup withholding on all such payments until you provide your TIN to the requester.

Note. Entering "Applied For" means that you have already applied for a TIN or that you intend to apply for one soon.

Caution: A disregarded U.S. entity that has a foreign owner must use the appropriate Form W-8.

Part II. Certification

To establish to the withholding agent that you are a U.S. person, or resident alien, sign Form W-9. You may be requested to sign by the withholding agent even if items 1, 4, or 5 below indicate otherwise.

For a joint account, only the person whose TIN is shown in Part I should sign (when required). In the case of a disregarded entity, the person identified on line 1 must sign. Exempt payees, see *Exempt payee code* earlier.

Signature requirements. Complete the certification as indicated in items 1 through 5 below.

1. Interest, dividend, and barter exchange accounts opened before 1984 and broker accounts considered active during 1983. You must give your correct TIN, but you do not have to sign the certification.

2. Interest, dividend, broker, and barter exchange accounts opened after 1983 and broker accounts considered inactive during 1983. You must sign the certification or backup withholding will apply. If you are subject to backup withholding and you are merely providing your correct TIN to the requester, you must cross out item 2 in the certification before signing the form.

3. Real estate transactions. You must sign the certification. You may cross out item 2 of the certification.

4. Other payments. You must give your correct TIN, but you do not have to sign the certification unless you have been notified that you have previously given an incorrect TIN. "Other payments" include payments made in the course of the requester's trade or business for rents, royalties, goods (other than bills for merchandise), medical and health care services (including payments to corporations), payments to a nonemployee for services, payments made in settlement of payment card and third party network transactions, payments to certain fishing boat crew members and fishermen, and gross proceeds paid to attorneys (including payments to corporations).

5. Mortgage interest paid by you, acquisition or abandonment of secured property, cancellation of debt, qualified tuition program payments (under section 529), IRA, Coverdell ESA, Archer MSA or HSA contributions or distributions, and pension distributions. You must give your correct TIN, but you do not have to sign the certification.

What Name and Number To Give the Requester

| For this type of account: | Give name and SSN of: |
|---|---|
| 1. Individual | The individual |
| 2. Two or more individuals (joint account) | The actual owner of the account or, if combined funds, the first individual on the account ¹ |
| 3. Custodian account of a minor (Uniform Gift to Minors Act) | The minor ² |
| 4. a. The usual revocable savings trust (grantor is also trustee) b. So-called trust account that is not a legal or valid trust under state law | The grantor-trustee ¹ The actual owner ¹ |
| 5. Sole proprietorship or disregarded entity owned by an individual | The owner ³ |
| 6. Grantor trust filing under Optional Form 1099 Filing Method 1 (see Regulations section 1.671-4(b)(2)(i)(A)) | The grantor* |
| For this type of account: | Give name and EIN of: |
| 7. Disregarded entity not owned by an individual | The owner |
| 8. A valid trust, estate, or pension trust | Legal entity ⁴ |
| 9. Corporation or LLC electing corporate status on Form 8832 or Form 2553 | The corporation |
| 10. Association, club, religious, charitable, educational, or other tax-exempt organization | The organization |
| 11. Partnership or multi-member LLC | The partnership |
| 12. A broker or registered nominee | The broker or nominee |
| 13. Account with the Department of Agriculture in the name of a public entity (such as a state or local government, school district, or prison) that receives agricultural program payments | The public entity |
| 14. Grantor trust filing under the Form 1041 Filing Method or the Optional Form 1099 Filing Method 2 (see Regulations section 1.671-4(b)(2)(i)(B)) | The trust |

¹ List first and circle the name of the person whose number you furnish. If only one person on a joint account has an SSN, that person's number must be furnished.

² Circle the minor's name and furnish the minor's SSN.

³ You must show your individual name and you may also enter your business or DBA name on the "Business name/disregarded entity" name line. You may use either your SSN or EIN (if you have one), but the IRS encourages you to use your SSN.

⁴ List first and circle the name of the trust, estate, or pension trust. (Do not furnish the TIN of the personal representative or trustee unless the legal entity itself is not designated in the account title.) Also see *Special rules for partnerships* on page 2.

*Note. Grantor also must provide a Form W-9 to trustee of trust.

Note. If no name is circled when more than one name is listed, the number will be considered to be that of the first name listed.

Secure Your Tax Records from Identity Theft

Identity theft occurs when someone uses your personal information such as your name, SSN, or other identifying information, without your permission, to commit fraud or other crimes. An identity thief may use your SSN to get a job or may file a tax return using your SSN to receive a refund.

To reduce your risk:

- Protect your SSN,
- Ensure your employer is protecting your SSN, and
- Be careful when choosing a tax preparer.

If your tax records are affected by identity theft and you receive a notice from the IRS, respond right away to the name and phone number printed on the IRS notice or letter.

If your tax records are not currently affected by identity theft but you think you are at risk due to a lost or stolen purse or wallet, questionable credit card activity or credit report, contact the IRS Identity Theft Hotline at 1-800-908-4490 or submit Form 14039.

For more information, see Publication 4535, Identity Theft Prevention and Victim Assistance.

Victims of identity theft who are experiencing economic harm or a system problem, or are seeking help in resolving tax problems that have not been resolved through normal channels, may be eligible for Taxpayer Advocate Service (TAS) assistance. You can reach TAS by calling the TAS toll-free case intake line at 1-877-777-4778 or TTY/TDD 1-800-829-4059.

Protect yourself from suspicious emails or phishing schemes. Phishing is the creation and use of email and websites designed to mimic legitimate business emails and websites. The most common act is sending an email to a user falsely claiming to be an established legitimate enterprise in an attempt to scam the user into surrendering private information that will be used for identity theft.

The IRS does not initiate contacts with taxpayers via emails. Also, the IRS does not request personal detailed information through email or ask taxpayers for the PIN numbers, passwords, or similar secret access information for their credit card, bank, or other financial accounts.

If you receive an unsolicited email claiming to be from the IRS, forward this message to phishing@irs.gov. You may also report misuse of the IRS name, logo, or other IRS property to the Treasury Inspector General for Tax Administration (TIGTA) at 1-800-366-4484. You can forward suspicious emails to the Federal Trade Commission at: spam@uce.gov or contact them at www.ftc.gov/idtheft or 1-877-IDTHEFT (1-877-438-4338).

Visit IRS.gov to learn more about identity theft and how to reduce your risk.

Privacy Act Notice

Section 6109 of the Internal Revenue Code requires you to provide your correct TIN to persons (including federal agencies) who are required to file information returns with the IRS to report interest, dividends, or certain other income paid to you; mortgage interest you paid; the acquisition or abandonment of secured property; the cancellation of debt; or contributions you made to an IRA, Archer MSA, or HSA. The person collecting this form uses the information on the form to file information returns with the IRS, reporting the above information. Routine uses of this information include giving it to the Department of Justice for civil and criminal litigation and to cities, states, the District of Columbia, and U.S. commonwealths and possessions for use in administering their laws. The information also may be disclosed to other countries under a treaty, to federal and state agencies to enforce civil and criminal laws, or to federal law enforcement and intelligence agencies to combat terrorism. You must provide your TIN whether or not you are required to file a tax return. Under section 3406, payers must generally withhold a percentage of taxable interest, dividend, and certain other payments to a payee who does not give a TIN to the payer. Certain penalties may also apply for providing false or fraudulent information.

Job No.: _____

TAX FORM/DEBT/ RESIDENCE CERTIFICATION
(for Advertised Projects)

Taxpayer Identification Number (T.I.N.): _____

Company Name submitting Bid/Proposal: _____

Mailing Address: _____

Are you registered to do business in the State of Texas? Yes No

If you are an individual, list the names and addresses of any partnership of which you are a general partner or any assumed name(s) under which you operate your business

I. **Property:** List all taxable property in Fort Bend County owned by you or above partnerships as well as any d/b/a names. Include real and personal property as well as mineral interest accounts. (Use a second sheet of paper if necessary.)

Fort Bend County Tax Acct. No.*

Property address or location**

* This is the property account identification number assigned by the Fort Bend County Appraisal District.

** For real property, specify the property address or legal description. For business personal property, specify the address where the property is located. For example, office equipment will normally be at your office, but inventory may be stored at a warehouse or other location.

II. **Fort Bend County Debt** - Do you owe any debts to Fort Bend County (taxes on properties listed in I above, tickets, fines, tolls, court judgments, etc.)?

Yes No If yes, attach a separate page explaining the debt.

III. **Residence Certification** - Pursuant to Texas Government Code §2252.001 *et seq.*, as amended, Fort Bend County requests Residence Certification. §2252.001 *et seq.* of the Government Code provides some restrictions on the awarding of governmental contracts; pertinent provisions of §2252.001 are stated below:

(3) "Nonresident bidder" refers to a person who is not a resident.

(4) "Resident bidder" refers to a person whose principal place of business is in this state, including a contractor whose ultimate parent company or majority owner has its principal place of business in this state.

I certify that _____ is a Resident Bidder of Texas as defined in Government Code §2252.001.
[Company Name]

I certify that _____ is a Nonresident Bidder as defined in Government Code §2252.001 and our principal place of business is _____.

[City and State]

Mandatory Form



Contractor Acknowledgement of Stormwater Management Program

I hereby acknowledge that I am aware of the stormwater management program and standard operating procedures developed by Fort Bend County in compliance with the TPDES General Permit No. TXR040000. I agree to comply with all applicable best management practices and standard operating procedures while conducting my services for Fort Bend County. I agree to conduct all services in a manner that does not introduce illicit discharges of pollutants to streets, stormwater inlets, drainage ditches or any portion of the drainage system. The following materials and/or pollutant sources must not be discharged to the drainage system as a result of any services provided:

1. Grass clippings, leaves, mulch, rocks, sand, dirt or other waste materials resulting from landscaping activities, (except those materials resulting from ditch mowing or maintenance activities)
2. Herbicides, pesticides and/or fertilizers, (except those intended for aquatic use)
3. Detergents, fuels, solvents, oils and/or lubricants, other equipment and/or vehicle fluids,
4. Other hazardous materials including paints, thinners, chemicals or related waste materials,
5. Uncontrolled dewatering discharges, equipment and/or vehicle wash waters,
6. Sanitary waste, trash, debris, or other waste products
7. Wastewater from wet saw machinery,
8. Other pollutants that degrade water quality or pose a threat to human health or the environment.

Furthermore, I agree to notify Fort Bend County immediately of any issue caused by or identified by:

(Company/Contractor)

that is believed to be an immediate threat to human health or the environment.

Contractor Signature

Date

Printed Name

Title



FORT BEND COUNTY - WEST TOWER JAIL HOT WATER DISTRIBUTION REPAIRS

FORT BEND COUNTY JAIL
1410 WILLIAMS WAY BLVD
RICHMOND, TX 77469

APRIL 5, 2018

ISSUE FOR BID & CONSTRUCTION

Project Number: 222110692

| ABBREVIATIONS | | SHEET SYMBOLS | | PLUMBING ROUGH-IN SCHEDULE | | | | GENERAL NOTES |
|---------------|----------------------------------|---|---|---|--|--|--|---------------|
| CW | COLD WATER SUPPLY | <p>1 DETAIL TITLE 1/8" = 1'-0"</p> <p>REFER TO DRAWING/DETAIL NUMBER RE: 3/P4.01 REFERENCE TAG P4.01 SHEET NUMBER</p> <p>TYPE OF SERVICE (I.E. HW = HOT WATER) RISER BUBBLE RISER NUMBER</p> <p>XX EQUIPMENT TAG SK-1 FIXTURE TAG 1 KEYNOTE 1 REVISION</p> | <p>MARK FIXTURE CONNECTION SIZES C.W. H.W. WASTE VENT</p> <p>HOT WATER PIPE & VALVES - 1" - -</p> <p>COLD WATER PIPE & VALVES VARIES - - -</p> <p>PLUMBING PIPING MATERIALS FUNCTION: MATERIAL: DOMESTIC HOT & COLD WATER TYPE "L" COPPER</p> <p>WORK IN EXISTING BUILDING</p> <p>INCLUDES 1. RELOCATION, REMOVAL, OR ABANDONMENT OF PLUMBING EQUIPMENT AND SYSTEMS REQUIRED IN CONJUNCTION WITH THE WORK IN AN EXISTING BUILDING. 2. PROVIDING TEMPORARY PROVISIONS FOR ALL EXISTING AND/OR NEW PIPING AND SYSTEMS TO MAINTAIN OCCUPANCY IN ADJACENT AREAS. TEMPORARY PROVISIONS INCLUDE, BUT ARE NOT LIMITED TO PIPING, VALVES, AND MISCELLANEOUS MATERIALS AS REQUIRED TO SUPPORT PLUMBING SYSTEMS PRIOR TO THE COMPLETION OF NEW PLUMBING SYSTEMS OPERATION. 3. REMOVE: REFERS TO PLUMBING EQUIPMENT AND SYSTEMS THAT ARE NOT TO BE REUSED AND ARE TO BE REMOVED FROM THE JOB SITE AND DISPOSED OF AS DIRECTED BY THE OWNER.</p> <p>MATERIALS 4. PROVIDE MATERIALS TO MATCH EXISTING CONSTRUCTION UNLESS SPECIFIED ELSEWHERE IN THESE CONTRACT DOCUMENTS. PROVIDE MATERIALS THAT COMPLY WITH LOCAL CODES, ARI, AMCA, AND UL, AND PROPERLY APPLY TO THEIR INTENDED FUNCTION.</p> <p>PREPARATION 5. VISIT AND INSPECT JOB SITE PRIOR TO BIDDING; BECOME FAMILIAR WITH EXISTING CONDITIONS. INCLUDE COST OF WORK REQUIRED TO ACCOMMODATE EXISTING CONDITIONS IN BID PROPOSAL. 6. PROVIDE TYPED INVENTORY (INCLUDE PICTURES AS NECESSARY) OF EQUIPMENT AND FACILITIES THAT ARE DAMAGED OR NOT OPERATING PROPERLY AT THE TIME CONSTRUCTION COMMENCES. DAMAGE OR INOPERATIVE EQUIPMENT THAT IS DISCOVERED DURING COURSE OF CONSTRUCTION AND NOT ITEMIZED ON WRITTEN INVENTORY WILL BE ASSUMED TO HAVE BEEN CAUSED BY THE CONTRACTOR, AND THE CONTRACTOR WILL BE RESPONSIBLE FOR REPAIR OR REPLACEMENT AT NO ADDITIONAL COST.</p> <p>RENOVATION 7. RELOCATE EXISTING MATERIAL REQUIRED TO ACCOMMODATE THE NEW CONSTRUCTION WHETHER OR NOT THE EXISTING MATERIAL IS SHOWN ON DRAWINGS. 8. REMOVAL OF EQUIPMENT OR SYSTEMS IDENTIFIED ON DRAWINGS TO BE REMOVED, INCLUDING SUPPORTS, APPURTENANCES, AND ACCESSORIES ASSOCIATED WITH EQUIPMENT OR SYSTEMS. 9. CONNECT EQUIPMENT WHICH IS EXISTING AND IS TO REMAIN TO NEW SYSTEM AS REQUIRED TO MAINTAIN ITS PROPER OPERATION. 10. REMOVE WITH CARE EQUIPMENT TO BE REPLACED. REPAIR OR REPLACE DAMAGED EQUIPMENT AS REQUIRED.</p> <p>SHUTDOWN OF PLUMBING SERVICES 11. ESTABLISH SCHEDULE OF SHUTDOWNS COMPLETE WITH STARTING TIME AND DURATION. 12. PRESENT SCHEDULE TO OWNER FOR APPROVAL. 13. REVISE SCHEDULE AS NECESSARY TO COORDINATE WITH OWNER. 14. BEYOND ANY SCHEDULED SHUTDOWNS, MAINTAIN CONTINUITY OF PLUMBING SERVICES TO ALL EXISTING FACILITIES.</p> | <p>A. CONTRACTOR SHALL COMPLY WITH ALL LOCAL, STATE AND FEDERAL CODES AND AUTHORITIES HAVING JURISDICTION.</p> <p>B. CONTRACTOR SHALL PROVIDE LABOR AND MATERIALS AS REQUIRED TO MAKE FINAL CONNECTIONS FOR ALL PLUMBING FIXTURES, EQUIPMENT AND RELATED ITEMS PROVIDED UNDER SEPARATE DIVISIONS.</p> <p>C. CONTRACTOR SHALL FIELD VERIFY EXACT LOCATIONS AND ELEVATIONS OF PROPOSED POINTS OF CONNECTION WITH EXISTING BUILDING PLUMBING UTILITY LINES PRIOR TO INSTALLATION OF ANY NEW WORK.</p> <p>D. CONTRACTOR SHALL COORDINATE WITH STRUCTURAL CONDITIONS AT EXISTING AND PROVIDE PROPER PIPING INSTALLATIONS AS REQUIRED WITHOUT DAMAGE TO STRUCTURE, WHERE STRUCTURAL MODIFICATIONS ARE TO BE REQUIRED, CONTRACTOR SHALL FIRST RECEIVE WRITTEN APPROVAL OF THE ENGINEER.</p> <p>E. CONTRACTOR SHALL BE RESPONSIBLE FOR FIELD COORDINATING LOCATIONS AND ELEVATIONS OF ALL PLUMBING PIPING WITH OTHER TRADES PRIOR TO INSTALLATION, WHERE RELOCATIONS OF NEW WORK ARE REQUIRED TO CORRECT CONFLICTS WITH OTHER TRADES IT SHALL BE DONE AT NO ADDITIONAL COST TO OWNER.</p> <p>F. ALL PIPE PASSING THROUGH FIRE RATED WALLS OR FLOOR SLAB SHALL BE SUPPORTED AT THE PENETRATION AND SHALL BE SEALED WITH APPROVED FIRE STOP MATERIALS AS SPECIFIED AND REQUIRED BY CODE AUTHORITIES HAVING JURISDICTION.</p> <p>G. CONTRACTOR SHALL BE RESPONSIBLE FOR FIELD COORDINATING ALL PLUMBING PIPING SLEEVE LOCATIONS WITH ALL OTHER TRADES PRIOR TO INSTALLATION OF ANY PIPING OR SUPPORTS.</p> <p>H. DO NOT SCALE PLUMBING DRAWINGS FOR FIELD ROUGH-IN WORK. CONTRACTOR SHALL REFER TO THE DIMENSIONED ARCHITECTURAL AND STRUCTURAL DRAWINGS TO FIELD DETERMINE EXACT LOCATIONS OF ROUGH-IN WORK.</p> <p>I. PROVIDE ISOLATING BALL VALVES FOR ALL BRANCHES OFF DOMESTIC WATER MAINS. ALL PLUMBING SYSTEM VALVES SHALL BE INSTALLED IN ACCESSIBLE CEILING SPACES, WHERE CEILING IS NOT ACCESSIBLE, OR SPACE IS CONFLICTING, VALVES SHALL BE INSTALLED IN PARTITIONS OR PIPE CHASES. PROVIDE MILCOR STYLE K-PAINTED STEEL HINGED ACCESS PANELS IN LOCATIONS PRE-APPROVED BY THE ENGINEER.</p> <p>J. ALL HOT WATER AND HOT WATER CIRCULATING RETURN PIPING SHALL BE GLASS CONSULTATION WITH ALL SERVICE JACKET WITH SELF SEALING LAP JOINT.</p> <p>K. CONTRACTOR SHALL STERILIZE ALL NEW DOMESTIC WATER PIPING ACCORDING TO AMERICAN WATER WORKS ASSOCIATION (AWWA) SPECIFICATIONS.</p> <p>L. EXISTING PIPING, WHERE SHOWN, ARE PRESUMED LOCATIONS TAKEN FROM EXISTING DRAWINGS OR OTHER INFORMED SOURCES. IF ANY VARIATIONS ARE FOUND FROM THAT SHOWN ON THE DRAWINGS, NOTIFY THE ENGINEER IMMEDIATELY.</p> <p>M. IT IS STRONGLY RECOMMENDED THAT THE CONTRACTOR WALK THE SITE PRIOR TO SUBMISSION OF A BID PROPOSAL TO GAIN FULL UNDERSTANDING OF THE SCOPE OF WORK.</p> <p>N. ALL PIPING BEING EXPOSED DURING RENOVATION THAT IS NOT IDENTIFIED/LABELED SHALL BE IDENTIFIED WITH PIPE MARKERS FOR BOTH TYPE OF SERVICE AND DIRECTION OF FLOW.</p> <p>O. PRESSURE RATINGS FOR ALL PIPING AND FITTING MATERIALS SHALL BE PER EQUIPMENT MANUFACTURER REQUIREMENTS.</p> <p>P. CONTRACTOR SHALL PROVIDE DIELECTRIC UNIONS FOR ALL CONNECTION POINTS OF DISSIMILAR METALS AS IT PERTAINS TO THE DOMESTIC WATER SYSTEMS.</p> <p>Q. ALL PIPING, VALVES EQUIPMENT AND APPURTENANCES SHALL BE LOCATED CLEAR OF OBSTRUCTIONS FOR MAINTENANCE; COORDINATE WITH ALL TRADES PRIOR TO INSTALLATION.</p> <p>R. WHERE POSSIBLE, INSTALL PIPING IN ACCESSIBLE CHASES.</p> <p>S. COORDINATE SHUTDOWNS WITH OWNER. GIVE 48 HOURS NOTICE PRIOR TO ANY SHUTDOWN OF DOMESTIC SYSTEMS.</p> | | | | |
| HW | HOT WATER SUPPLY | | | | | | | |
| HWR | HOT WATER RETURN | | | | | | | |
| V | VENT LINE | | | | | | | |
| | FIRE LINE | | | | | | | |
| SA | STORM DRAIN | | | | | | | |
| RDL | ROOF DRAIN LINE | | | | | | | |
| ROL | ROOF OVERFLOW LINE | | | | | | | |
| SV | SANITARY VENT | | | | | | | |
| SAN | SOIL & WASTE | | | | | | | |
| GW | WASTE TO GREASE TRAP | | | | | | | |
| CRD | CORROSION RESISTANT WASTE | | | | | | | |
| SSD | SUB-SURFACE DRAIN | | | | | | | |
| NG | GAS LINE | | | | | | | |
| F | FIRE LINE | | | | | | | |
| SP | FIRE SPRINKLER LINE | | | | | | | |
| CA | COMPRESSED AIR LINE | | | | | | | |
| CD | CONDENSATE LINE | | | | | | | |
| SSA | SANITARY LINE ABOVE GROUND | | | | | | | |
| SSB | SANITARY LINE BELOW GROUND | | | | | | | |
| AV | ACID VENT | | | | | | | |
| D | DRAIN LINE | | | | | | | |
| TW | TEMPERED WATER | | | | | | | |
| SW | SOFTENED WATER | | | | | | | |
| IW | ICE WATER | | | | | | | |
| IWR | ICE WATER RETURN | | | | | | | |
| N | NITROGEN | | | | | | | |
| NV | NITROGEN VENT | | | | | | | |
| BSL | BEVERAGE SUPPLY LINE | | | | | | | |
| ODL | OVER FLOW DRAIN LINE | | | | | | | |
| VAC | VACUUM | | | | | | | |
| WC | WATER CLOSET | | | | | | | |
| L | LAVATORY | | | | | | | |
| BT-1 | BATHTUB | | | | | | | |
| B- | BIDET | | | | | | | |
| SS | SERVICE SINK | | | | | | | |
| MS | MOP SINK | | | | | | | |
| U | URINAL | | | | | | | |
| SK | SINK | | | | | | | |
| DF | DRINKING FOUNTAIN | | | | | | | |
| EWC | ELECTRIC WATER COOLER | | | | | | | |
| DS | DOWNSPOUT | | | | | | | |
| CO | CLEAN OUT | | | | | | | |
| FCO | FLOOR CLEAN OUT | | | | | | | |
| WCO | WALL CLEAN OUT | | | | | | | |
| LH | LAWN HYDRANT | | | | | | | |
| WH | WALL HYDRANT WITH VACUUM BREAKER | | | | | | | |
| HB | HOSE BIBB WITH VACUUM BREAKER | | | | | | | |
| VTR | VENT THROUGH ROOF | | | | | | | |
| AP | ACCESS PANEL | | | | | | | |
| A.F.F. | ABOVE FINISHED FLOOR | | | | | | | |
| B.F.F. | BELOW FINISHED FLOOR | | | | | | | |
| FDC | FIRE DEPARTMENT CONNECTION | | | | | | | |
| FHC | FIRE HOSE CABINET | | | | | | | |
| FHR | FIRE HOSE RACK | | | | | | | |
| | F.F.D. FUNNEL FLOOR DRAIN | | | | | | | |
| | F.D. FLOOR DRAIN | | | | | | | |
| | F.S. FLOOR SINK | | | | | | | |
| | O.D. OVERFLOW DRAIN | | | | | | | |
| | R.D. ROOF DRAIN | | | | | | | |
| | A.D. AREA DRAIN | | | | | | | |
| | GATE VALVE | | | | | | | |
| | PLUG VALVE | | | | | | | |
| | CHECK VALVE | | | | | | | |
| | GLOBE VALVE | | | | | | | |
| | BUTTERFLY VALVE | | | | | | | |
| | STRAINER | | | | | | | |
| | CLEAN OUT | | | | | | | |
| | FLOOR CLEAN OUT | | | | | | | |
| | WALL CLEAN OUT | | | | | | | |
| | VACUUM RELIEF VALVE | | | | | | | |
| | BALL VALVE | | | | | | | |
| | UNION OR FLANGE | | | | | | | |
| | GAS COCK | | | | | | | |

| | |
|------------------------------|------------------------------------|
| ISSUE FOR BID & CONSTRUCTION | 2018.04.05 |
| Issued/Revision | By Appd YYYY.MM.DD |
| File Name: N/A | Author Designer Checker 2018.03.14 |
| | Dwn. Dgn. Chkd. YYYY.MM.DD |

Permit/Seal

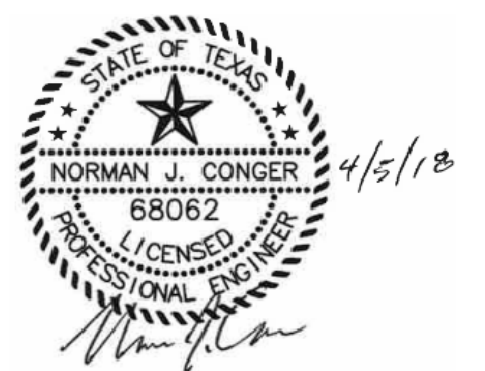

FORT BEND COUNTY JAIL
1410 WILLIAMS WAY BLVD
RICHMOND, TX 77469

Client/Project
FORT BEND COUNTY -
WEST TOWER JAIL

HOT WATER DISTRIBUTION REPAIRS

Title
PLUMBING LEGEND AND SYMBOLS

| | |
|--------------------------|----------------------------|
| Project No. 222110692 | Scale NONE |
| Revision | Drawing No. P0.1 |

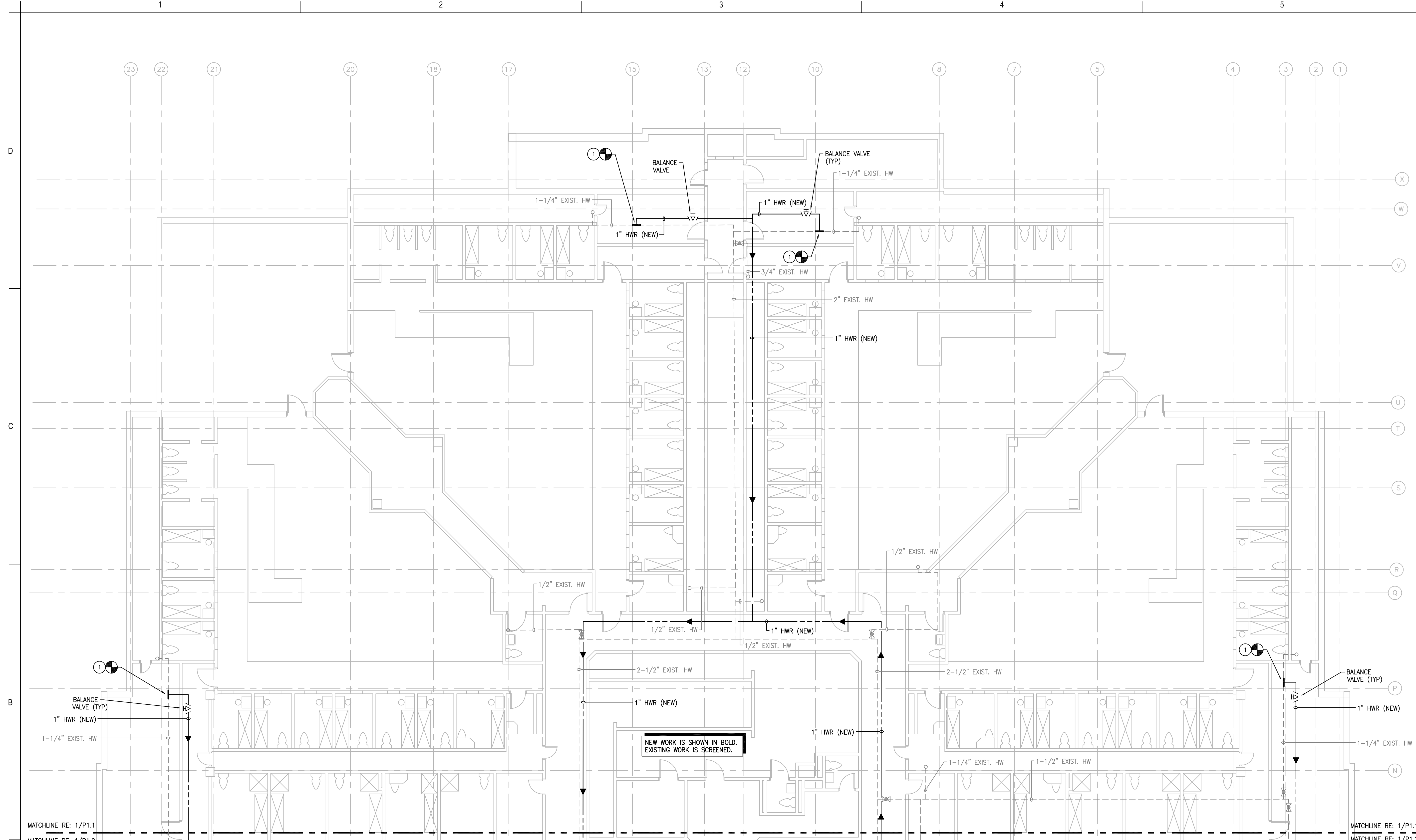

1 PLUMBING PLAN - LEVELS 2 AND 4 - AREA A
SCALE: 1/8" = 1'-0"

GENERAL NOTES:

1. ALL NEW PLUMBING PIPE SHALL BE INSTALLED IN THE MOST ACCESSIBLE LOCATION AS POSSIBLE. PIPE AND VALVES AS SHOWN IS THE MOST PRUDENT LOCATION BASED ON THE PREVIOUS DOCUMENTS AND SITE VISITS. IF THE CONTRACTOR SEES AN EASIER ROUTE BASED ON HIS OBSERVATIONS IN THE FIELD, HE SHALL PRESENT HIS SKETCH TO THE OWNER AND ENGINEER FOR REVIEW.

GENERAL NOTES:

1. ALL PIPING AND VALVES ARE INTENDED TO BE LOCATED WITHIN THE ACCESSIBLE CHASE - DOCUMENTS MAY REFLECT COMPONENTS, ETC. OUTSIDE THE CHASE, BUT THEY ARE ONLY SHOWN IN THAT LOCATION FOR CLARITY.

PLUMBING KEYNOTES

1. CONNECT NEW 1" HWR PIPE TO EXISTING 1-1/4" HW PIPE WITH BALANCE VALVE.

| ISSUE FOR BID & CONSTRUCTION | By | Appd | 2018.04.05 |
|------------------------------|--------|----------|------------|
| Issued/Revision | | | YYYY.MM.DD |
| File Name: N/A | Author | Designer | Checker |
| | Dwn. | Dgn. | Chkd. |
| | | | 2018.03.14 |
| | | | YYYY.MM.DD |

Permit/Seal

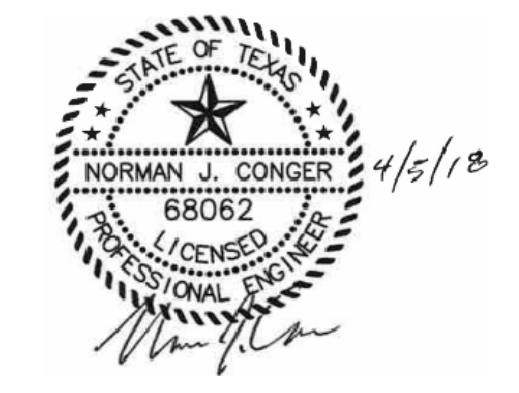

FORT BEND COUNTY JAIL
1410 WILLIAMS WAY BLVD
RICHMOND, TX 77469

Client/Project
FORT BEND COUNTY -
WEST TOWER JAIL

HOT WATER DISTRIBUTION REPAIRS

Title
PLUMBING PLAN - LEVELS 2 AND 4
-AREA A

Project No. 222110692
Revision
Scale 1/8" = 1'-0"
Drawing No.

P1.1

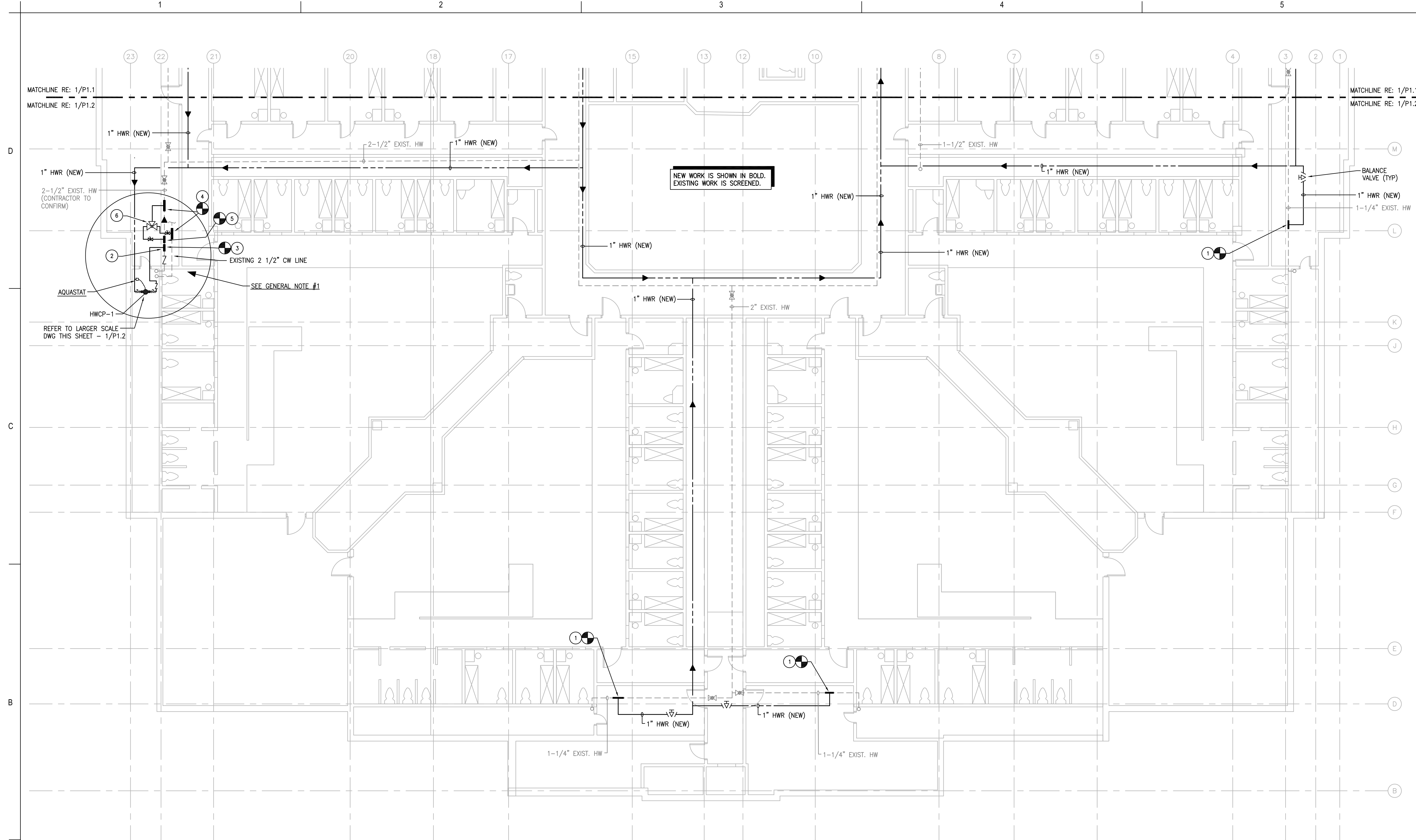

| Issue/Revision | By | Appd | Date |
|------------------------------|----|------|------------|
| ISSUE FOR BID & CONSTRUCTION | | | 2018.04.05 |
| Issued/Revision | | | YYYY.MM.DD |

| File Name | Author | Designer | Checker | Date |
|-----------|--------|----------|---------|------------|
| N/A | | | | 2018.03.14 |
| | Dwn. | Dgn. | Chkd. | YYYY.MM.DD |

Permit/Seal



FORT BEND COUNTY JAIL
1410 WILLIAMS WAY BLVD
RICHMOND, TX 77469

Client/Project
FORT BEND COUNTY -
WEST TOWER JAIL

HOT WATER DISTRIBUTION REPAIRS

Title
PLUMBING PLAN - LEVELS 2 AND 4
-AREA B

Project No. 222110692
Revision
Scale 1/8" = 1'-0"
Drawing No.

P1.2

1 PLUMBING PLAN - LEVELS 2 AND 4 - AREA B
SCALE: 1/8" = 1'-0"

GENERAL NOTES:

- ALL PIPING, VALVES, TMV'S & PUMPS ARE INTENDED TO BE LOCATED WITHIN THE ACCESSIBLE CHASE - DOCUMENTS MAY REFLECT COMPONENTS, ETC. OUTSIDE THE CHASE, BUT THEY ARE ONLY SHOWN IN THAT LOCATION FOR CLARITY.

PLUMBING KEYNOTES

- CONNECT NEW 1" HWR PIPE TO EXISTING 1-1/4" HW PIPE WITH BALANCE VALVE.
- CONNECT NEW 1" HWR PIPE TO EXISTING 1-1/4" HW PIPE.
- CONNECT NEW 1" HWR LINE TO EXISTING 1-1/4" HW SUPPLY.
- CONNECT NEW 2" CW LINE TO THE EXISTING 2-1/2" CW LINE W/ BALL VALVES, ROUTE TO THE TMV'S 1, 2 & 3; ROUGH-IN & CONNECT AS REQUIRED.
- CONNECT NEW 2" HW LINE TO THE EXISTING 2-1/2" HW LINE W/ BALL VALVES, ROUTE TO THE TMV'S 1, 2 & 3; ROUGH-IN & CONNECT AS REQUIRED.
- NEW 2" TMV (THERMOSTATIC MIXING VALVES - SET TO 110 DEG.)
TMV - 1 IS LOCATED 2ND FLR.
TMV - 2 IS LOCATED 4TH FLR.
TMV - 3 IS LOCATED 6TH FLR.

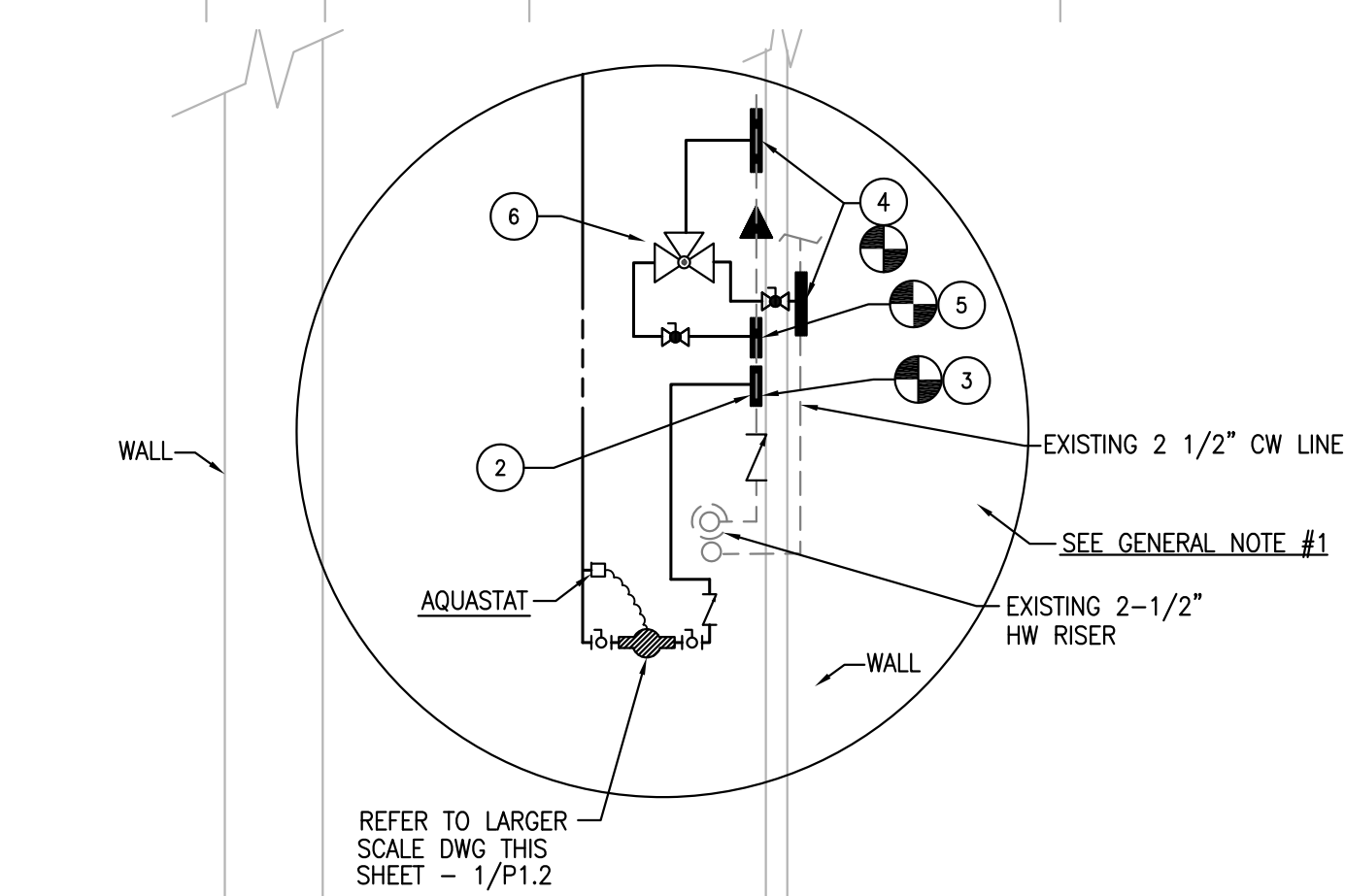

2 ENLARGED PARTIAL PLUMBING PLAN
SCALE: NONE

PROJECT SCOPE OF WORK

1. THE CONTRACTOR SHALL REMOVE THE MAIN TMV (THERMOSTATIC MIXING VALVE) FOR WEST TOWER JAIL AND RECONNECT THE HOT WATER SUPPLY PIPING. THE MAIN TMV IS LOCATED DIRECTLY BEHIND THE HEATER #1 AND THE HOT WATER STORAGE TANK IN THE MAIN CENTRAL PLANT.
2. THE CONTRACTOR SHALL RAISE THE DOMESTIC WATER TEMPERATURE TO 140° DEGREES F. AT THE HOT WATER STORAGE TANK. INTENT IS TO SUPPLY 140° HOT WATER TO TOWER (LEVELS 2-6), AND MIX TO 110° AT FLOORS 2, 4, AND 6 WITH NEW TMV'S INSTALLATION ON THOSE LEVELS OF THE WEST TOWER.
3. THE CONTRACTOR SHALL REMOVE IN ITS ENTIRETY THE HOT WATER RETURN "PEX" SYSTEM THROUGHOUT THE WEST TOWER FLOORS - ONE (1) INSTALLATION WAS LOCATED ON THE 2ND FLOOR IN THE 2F AREA CHASE; ANOTHER LOCATION WAS LEVEL 4 IN TWO (2) SEPARATE LOCATIONS, AREAS 4D & 4F.
4. ALL HOT WATER/HOT WATER RETURN TO LEVEL 1 OF TOWER IS SEPARATELY PIPED AND SHALL REMAIN AS-IS. MAINTAIN HOT/COLD WATER SERVICE TO ALL FLOORS.
5. CONTRACTOR TO PROVIDE 120 VOLT POWER FOR THE NEW CIRCULATION PUMPS (HWCP-1 & HWCP-2) WITHIN THE ACCESSIBLE CHASE.

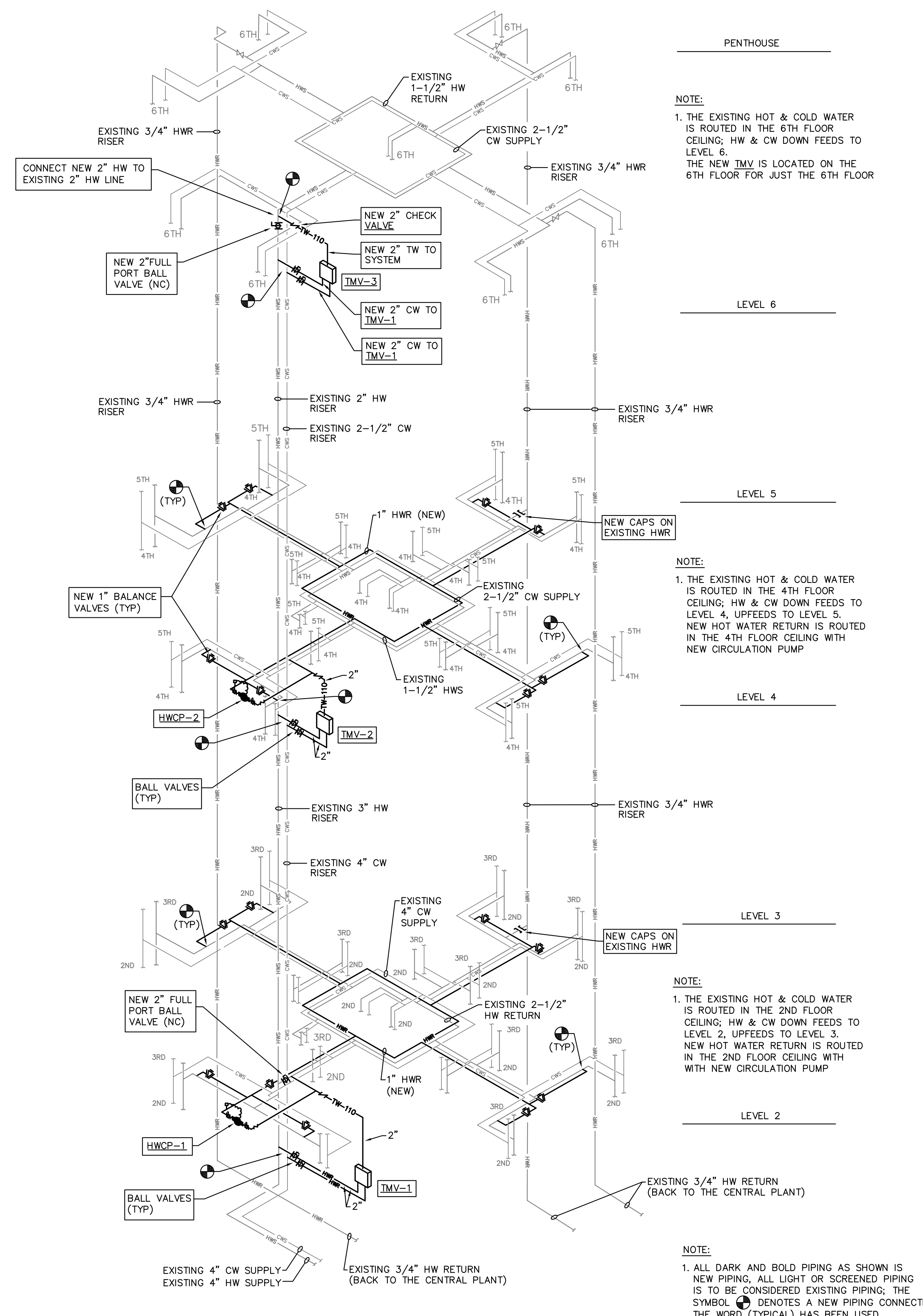

PENTHOUSE

NOTE:
1. THE EXISTING HOT & COLD WATER IS ROUTED IN THE 6TH FLOOR CEILING; HW & CW DOWN FEEDS TO LEVEL 6. THE NEW TMV IS LOCATED ON THE 6TH FLOOR FOR JUST THE 6TH FLOOR

LEVEL 6

LEVEL 5

NOTE:
1. THE EXISTING HOT & COLD WATER IS ROUTED IN THE 4TH FLOOR CEILING; HW & CW DOWN FEEDS TO LEVEL 4, UPFEEDS TO LEVEL 5. NEW HOT WATER RETURN IS ROUTED IN THE 4TH FLOOR CEILING WITH NEW CIRCULATION PUMP

LEVEL 4

LEVEL 3

NOTE:
1. THE EXISTING HOT & COLD WATER IS ROUTED IN THE 2ND FLOOR CEILING; HW & CW DOWN FEEDS TO LEVEL 2, UPFEEDS TO LEVEL 3. NEW HOT WATER RETURN IS ROUTED IN THE 2ND FLOOR CEILING WITH NEW CIRCULATION PUMP

LEVEL 2

NOTE:
1. ALL DARK AND BOLD PIPING AS SHOWN IS NEW PIPING. ALL LIGHT OR SCREENED PIPING IS TO BE CONSIDERED EXISTING PIPING; THE SYMBOL DENOTES A NEW PIPING CONNECTION THE WORD (TYPICAL) HAS BEEN USED.

1 HOT WATER RISER DIAGRAM
SCALE: NONE

| PUMP SCHEDULE | | | | | | | |
|---------------|-----------------------|---------|-----|----------|------|------------|---|
| MARK | SERVICE | TYPE | GPM | HEAD FT. | H.P. | VOLT/PH/Hz | REMARKS |
| HWCP-1 | HOT WATER CIRCULATING | IN-LINE | 5 | 7 | 1/16 | 120/1/60 | GRUNDFOS - ALPHA2 15-55-SF S.S. - VARIABLE-SPEED CIRCULATOR |
| HWCP-2 | HOT WATER CIRCULATING | IN-LINE | 5 | 7 | 1/16 | 120/1/60 | GRUNDFOS - ALPHA2 15-55-SF S.S. - VARIABLE-SPEED CIRCULATOR |

NOTE: CONTRACTOR SHALL PROVIDE 120 VOLT POWER TO THE NEW HWCP'S, TWO (2); MAXIMUM POWER USAGE IS 45 WATTS

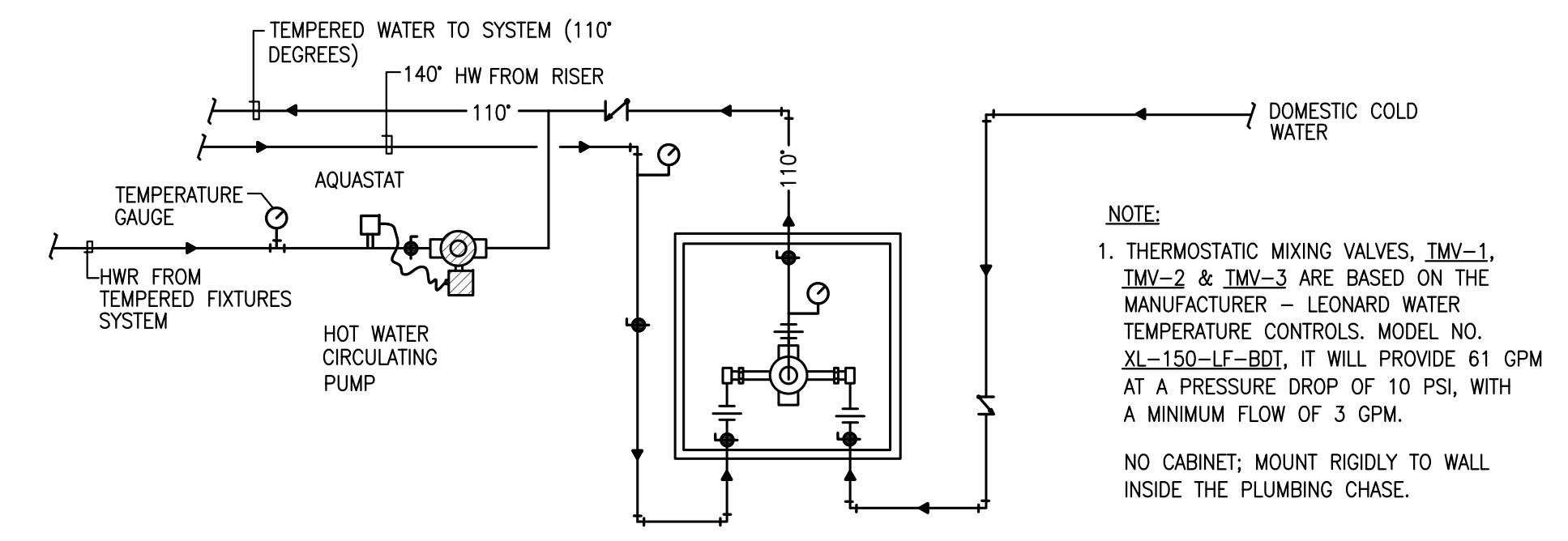

NOTE:
1. THERMOSTATIC MIXING VALVES, TMV-1, TMV-2 & TMV-3 ARE BASED ON THE MANUFACTURER - LEONARD WATER TEMPERATURE CONTROLS. MODEL NO. XL-150-LE-BOT. IT WILL PROVIDE 61 GPM AT A PRESSURE DROP OF 10 PSI, WITH A MINIMUM FLOW OF 3 GPM.
NO CABINET; MOUNT RIGIDLY TO WALL INSIDE THE PLUMBING CHASE.

2 THERMOSTATIC MIXING VALVE DETAIL
SCALE: NONE

| ISSUE FOR BID & CONSTRUCTION | By | Appd | 2018.04.05 |
|------------------------------|--------|----------|------------|
| Issued/Revision | | | YYYY.MM.DD |
| File Name: N/A | Author | Designer | Checker |
| | Dwn. | Dgn. | Chkd. |
| | | | 2018.03.14 |
| | | | YYYY.MM.DD |

Permit/Seal

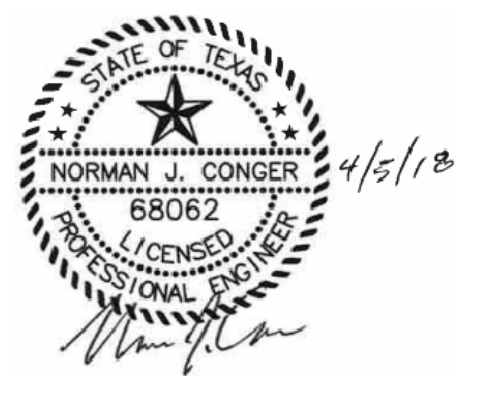

Author Design



FORT BEND COUNTY JAIL
1410 WILLIAMS WAY BLVD
RICHMOND, TX 77469

Client/Project
FORT BEND COUNTY -
WEST TOWER JAIL

HOT WATER DISTRIBUTION REPAIRS

Title
PLUMBING RISER DIAGRAM

| | |
|--------------------------|---------------------|
| Project No. 222110692 | Scale NONE |
| Revision | Drawing No. P3.1 |